

CAUTION

The earthing requirements for ground-mounted distribution substations in this document are no longer applicable. Please refer to Standard Techniques TP21DD and TP21GA to TP21GH instead.

Company Directive

STANDARD TECHNIQUE: TP21D/4

11kV, 6.6kV and LV Earthing

Policy Summary

This document specifies requirements for earthing 11kV and 6.6kV and LV equipment and systems.

Author: Graham Brewster

Implementation Date: June 2021

Approved by

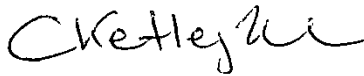

Engineering Policy Manager

Date: 28th June 2021

Target Staff Group	Network Services Teams, Engineering Trainers & ICPs
Impact of Change	AMBER - The changes have an impact of current working practices that are not safety critical - Communication at next team meeting or as part of a retraining programme
Planned Assurance checks	None

NOTE: The current version of this document is stored in the WPD Corporate Information Database. Any other copy in electronic or printed format may be out of date. Copyright © 2021 Western Power Distribution

IMPLEMENTATION PLAN

Introduction

This document defines company requirements for earthing systems at 11kV and below.

Main Changes

The following aspects have been modified:

- Earthing requirements for ground-mounted distribution substations now contained in TP21DD and TP21GA to TP21GH inclusive. Advisory messages have been included in this document and text redacted where practicable
- No change of requirements for earthing of pole-mounted distribution substations or for LV earthing
- Additional earthing requirements for lightning protection made unambiguous in sections 5.6.2 & 5.8

Impact of Changes

Target Staff Group	Network Services Teams, Engineering Trainers & ICPs involved with the design and construction of earthing systems for ground mounted distribution substations
Impact of Change	AMBER - The changes have an impact of current working practices that are not safety critical – Communication at next team meeting or as part of a retraining programme

Implementation Actions

Team Managers responsible for relevant staff shall make them aware of this change.

Implementation Timetable

This ST shall be implemented with effect from 1st August 2021.

Where a connection offer is accepted prior to this date, the substation may be constructed in accordance with the requirements applicable at the time of acceptance, subject to the construction works being completed on or before 31st December 2021.

Where a requote is provided after the release of this document, the connection offer shall comply with the requirements of this document.

REVISION HISTORY

Document Revision & Review Table		
Date	Comments	Author
June 2021	<ul style="list-style-type: none"> • Earthing requirements for ground-mounted distribution substations now contained in TP21DD and TP21GA to TP21GH inclusive. Advisory messages have been included in this document and text redacted where practicable. • No change of requirements for pole mounted distribution substations and for LV earthing • Additional earthing requirements for lightning protection made unambiguous in sections 5.6.2 & 5.8. • Document brought into latest format, which resulted in some sections being renumbered. • A small number of typos and cross referencing errors corrected. 	Graham Brewster
Mar 2018	<ul style="list-style-type: none"> • Section 5.2.3 has been amended - diminished requirements for earthing conductor laid in parallel with HV cables when within the proximity of a Primary Substation. 	Graham Brewster
June 2017	<ul style="list-style-type: none"> • Section 5.2.1.1 has been amended to direct hot site enquires to the Primary Systems Design Team. 	Graham Brewster

Contents

1	INTRODUCTION	6
2	DEFINITIONS.....	6
3	GENERAL REQUIREMENTS	7
3.1	Statutory Requirements	7
3.1.1	<i>General</i>	7
3.1.2	<i>HV System Requirements.....</i>	7
3.1.3	<i>LV System Requirements</i>	8
3.1.4	<i>Earthing of Metalwork</i>	8
3.2	Hazardous Potentials.....	8
3.3	Fault Clearance.....	10
3.4	Over-voltage Protection	10
3.4.1	<i>Lightning Impulses.....</i>	10
4	ELECTRODE DESIGN	10
4.1	Maximum Resistance.....	10
4.1.1	<i>11kV and 6.6kV.....</i>	10
4.1.2	<i>Low Voltage (LV).....</i>	11
4.2	Thermal Requirements	11
4.2.1	<i>Conductor Fault Ratings</i>	11
4.2.2	<i>Surface Area Requirements</i>	12
4.3	Location of Earth Electrode.....	12
4.4	Standard Earth Electrode Arrangements	13
4.4.1	<i>Individual PME Earth Electrodes.....</i>	13
4.4.2	<i>Standard Earth Electrode Arrangements.....</i>	14
5	11KV AND 6.6KV EARTHING	24
5.1	System Earthing.....	24
5.1.1	<i>Earthing Arrangements</i>	24
5.2	Equipment Earthing.....	28
5.3	Determining Whether a Distribution Substation is Hot or Cold	28
5.3.1	<i>Continuous Metallic Earth Path Between The Primary And Distribution Substations</i>	29
5.3.2	<i>Discontinuous Metallic Earth Path Between The Primary And Distribution Substations</i>	30
5.3.3	<i>Worked Example 2: Determining Whether Substation Sites are Hot or Cold</i>	32
5.4	Distribution Substations – General.....	34

5.5	Distribution Substations - Combined HV and LV Earthing	34
5.5.1	<i>Ground Mounted and Pad Mounted Substations.....</i>	34
5.5.2	<i>Pole Mounted Substations.....</i>	38
5.6	Distribution Substations - Segregated HV and LV Earthing.....	40
5.6.1	<i>Ground Mounted and Pad Mounted Substations.....</i>	41
5.6.2	<i>Pole Mounted Substations.....</i>	46
5.7	Distribution Substations - Enclosures, Doors and Fencing.....	54
5.8	Distribution Substations - Pole Mounted Equipment (Excluding Transformers).....	60
5.8.1	<i>ABSDs with Handle Operated from Ground Level.....</i>	60
5.8.2	<i>Switchgear and Regulators with Ground Level Control Boxes.....</i>	61
5.9	HV Cables	65
6	LV EARTHING.....	65
6.1	System Earthing.....	65
6.1.1	<i>General LV System Earthing Requirements</i>	66
6.1.2	<i>Protective Multiple Earthing (PME).....</i>	66
6.1.3	<i>Protective Neutral Bonding (PNB)</i>	69
6.1.4	<i>Separate Neutral and Earth (SNE)</i>	70
6.1.5	<i>Direct Earthing.....</i>	71
6.2	Provision of SNE and PME Earthing Terminals	72
6.2.1	<i>CNE Mains System designed for PME Connections</i>	72
6.2.2	<i>SNE Systems that HAVE NOT been designed or modified for PME earthing</i>	73
6.2.3	<i>SNE Systems that HAVE been modified for PME earthing.....</i>	73
6.2.4	<i>Mixed SNE and CNE systems.....</i>	73
6.2.5	<i>Service Cables / Overhead Lines</i>	73
6.2.6	<i>Charging Arrangements for Providing or Modifying Earth Terminals</i>	74
7	BACKGROUND INFORMATION.....	80
7.1	Earth Electrode Thermal Calculations.....	80
7.1.1	<i>Fault Ratings.....</i>	80
7.1.2	<i>Surface Area of Electrode</i>	81
7.1.3	<i>Worked Example 3.....</i>	82
7.1.4	<i>Worked Example 4.....</i>	83
7.2	HV And LV Earth Segregation	83
7.3	Resistivity Of Different Soil / Rock Types.....	88

1 INTRODUCTION

The earthing requirements for ground-mounted distribution substations in this document are no longer applicable. Please refer to Standard Techniques TP21DD and TP21GA to TP21GH instead.

Text associated with superseded requirements has been redacted where practicable (text colour has been changed to blue and struck through).

This document specifies the design requirements for 11kV, 6.6kV and LV system earthing.

Detailed construction requirements are specified within the Overhead Line Manual, Jointing Manual and Substations and Plant (SP) policy series.

Requirements for major substation earthing are specified in ST: TP21B and in EESPEC 89.

2 DEFINITIONS

COLD SITE:	Any site containing HV equipment that is not a hot site.
EARTH ELECTRODE:	A conductor or group of conductors in intimate contact with, and providing an electrical connection to, earth.
EARTH IMPEDANCE:	The impedance between the earthing system and remote reference earth.
EARTH POTENTIAL:	The difference in potential which may exist between a point on the ground and remote reference earth.
EARTH RESISTANCE:	The resistance of the earth between the earth electrode and remote reference earth.
EARTHING CONDUCTOR:	A conductor that connects plant and equipment to an earth electrode.
EARTHING SYSTEM:	The complete interconnected assembly of earthing conductors and earth electrodes (including cables with un-insulated sheaths).
HOT SITE:	A site containing HV equipment where the rise of earth potential under earth fault conditions can exceed the limits of 430V or 650V, as applicable. The 650V limit only applies where the power system has an operating voltage of 33kV or greater and main protection is designed to clear earth faults within 200ms.
HOT ZONE:	The area over which the rise of earth potential may exceed the appropriate 650V or 430V limit.

PME EARTH	An earth electrode installed and connected to the LV neutral which helps to control the voltage that may appear on the neutral/earth conductor, should it become damaged or broken.
STEP VOLTAGE:	The potential difference between two points on the surface of the soil which are 1m apart.
TOUCH VOLTAGE	Voltage appearing during an insulation fault, between simultaneously accessible parts; hand-to-foot or hand-to-hand.

3 GENERAL REQUIREMENTS

Plant and equipment shall be adequately earthed in order to:

- satisfy statutory requirements.
- minimise the risk to staff and the general public from hazardous potentials.
- allow protection systems to detect and to remove earth faults from the network quickly and decisively and to minimise the number of customers affected by such fault.
- minimise equipment damage from lightning and power system faults.

3.1 Statutory Requirements

The Electricity Safety, Quality and Continuity Regulations 2002 (ESQCR) include a number of clauses related to earthing. A summary of these clauses is given below:

3.1.1 General

Regulation 8(1) requires Distributors to connect their networks to earth and ensure they remain connected to earth, so far as reasonably practicable, during fault conditions.

Regulation 10 requires Distributors to earth any metalwork not intended to operate as a phase conductor, that encloses, supports or is otherwise associated with equipment in their network, where necessary to prevent danger. This requirement is waived for metalwork associated with wood pole lines (where the metalwork is at least 3m above the ground) and for wall mounted metal brackets used to support overhead lines, where the line is supported by an insulator and the conductor that is in contact with the insulator is insulated.

Regulation 8(4) prevents Consumers combining neutral and earthing functions in a single conductor.

Regulation 8(3)(a) requires the outer conductor of any cable (or overhead line) consisting of concentric conductors to be connected to earth.

3.1.2 HV System Requirements

Regulation 8(2)(a) requires distributors to connect their HV network to earth at, or as close as is reasonably practicable to, the source of voltage. Where there is more than one source of voltage the connection to earth only has to be made at one point.

Regulation 8(2)(b) requires earth electrodes to be designed, installed and used to prevent danger occurring in any LV network as a result of a fault occurring in the HV network.

Regulation 8(2)(c) requires an alarm to be provided to warn the distributor when a fault is held on an arc suppression coil (Peterson coil).

3.1.3 LV System Requirements

Regulation 8(3)(b) requires every supply neutral conductor to be connected to earth at, or as near as is reasonably practicable, to the source of voltage except where connections are only made at one point on that network to a single source of voltage, in which case the earth connection can be made at the point of connection or at another point closer to the source of voltage.

Regulation 8(3)(c) specifies that no impedance may be inserted in any connection to earth except where this is required for the operation of switching devices, instruments, or equipment for control, telemetry or metering.

Regulation 9 specifies that, where a Distributor combines neutral and earthing functions within a single conductor (e.g. PME) or where the arrangement allowed under Regulation 8(3)(b) is used:

- The supply neutral conductor shall be connected to earth at a point no closer to the source of voltage than the most remote point beyond which 4 or more consumers are connected (of which one or more is provided with PME).
- The supply neutral conductor shall be connected to earth at other points as necessary to prevent danger arising from a broken supply neutral conductor.
- An earth terminal shall not be made available for a connection to a caravan or boat.

3.1.4 Earthing of Metalwork

Regulation 10 requires all metalwork enclosing, supporting or otherwise associated with generation equipment, distribution equipment or transmission equipment (except phase conductors) to be connected to earth, where this is necessary to prevent danger.

Metalwork which is attached to a wood pole that is designed and constructed so as to prevent, as reasonably practicable, danger within 3m of the ground, does not need to be earthed.

Wall mounted metal brackets which support overhead lines via insulators, do not need to be earthed, where the overhead lines (i.e. the conductors) are also insulated.

3.2 Hazardous Potentials

Any exposed conductor associated with network equipment metalwork that is not a phase conductor and that could be electrically energised must be earthed if it would otherwise create a hazard to people or to animals. Examples include:

- Cable screens and armouring
- Metal conduits
- Metal cabinets and enclosures
- Frames of motors, generators, transformers, switchgear
- Substation fencing
- Pipes

Pole cross-arms only need to be earthed where the other plant/equipment installed on the pole requires earthing. Wall mounted brackets supporting overhead lines do not have to be earthed if the line is connected to the bracket by an insulator and the part of the line in contact with the insulator is itself insulated.

Hazardous potentials can also occur on earthing systems when fault current flows to earth via an earth electrode. Under these circumstances the potential on the earth electrode, earthed metalwork and the ground in which the electrode is installed, rises. Differences in potential between metalwork, between metalwork and the surface of the ground or across the surface of the ground can be high enough to introduce an electrocution hazard for animals, and in some cases, to people. Figure 1 demonstrates how such potentials can arise. It should be noted that the length of time that a person is exposed to step or touch potentials has a significant bearing on the chance of that person experiencing a fatal electric shock.

Earthing systems are designed, as far as reasonably practicable, to eliminate hazardous potentials. Where hazards cannot be completely eliminated then steps shall be taken to minimise the risks. Where necessary, risk assessments shall be carried out to confirm that the risk is tolerable. Further guidance on limits for step, touch and transfer potentials is given in ST: TP21AA.

Figure 1: Step, Touch and Transfer Potentials

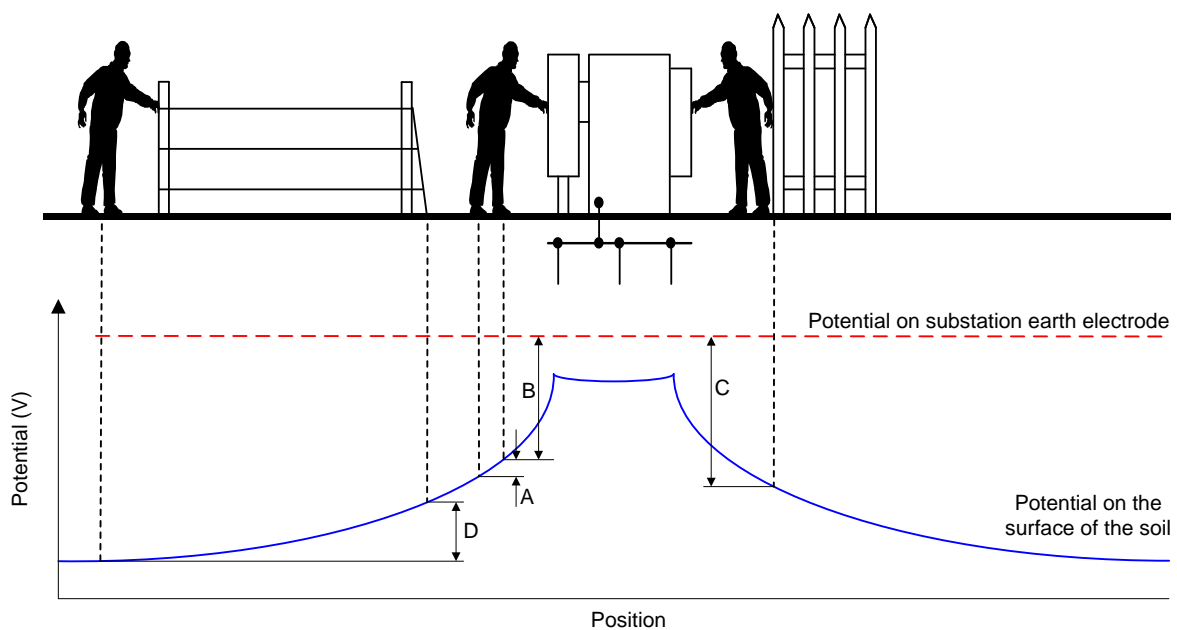

Note

- A Step potential (between feet)
- B Touch potential (between feet and hand)
- C Touch potential (between hands)
- D Potential transferred by wire fence causes a touch potential (between feet and hand)

3.3 Fault Clearance

The resistance of 11kV and 6.6kV earthing systems restrict available earth fault current. This is particularly relevant where an earth fault occurs on equipment fed via 11kV or 6.6kV overhead line, since standard lines do not include an earth wire. Fault current is forced to flow through the local earthing system to return to the source substation. In these circumstances a 20 ohm earth electrode, for example, will restrict 11kV earth fault current to less than 317A (ignoring other system impedances).

The resistance of the earthing system must be low enough to allow protection relays and fuses to detect fault current, discriminate with other protection and disconnect the fault quickly. Lowering the earth resistance also reduces, to some extent, the rise of earth potential at that location during earth faults. Also, the higher the earth fault current, the faster protection systems operate.

3.4 Over-voltage Protection

3.4.1 Lightning Impulses

Lighting impulses on WPD's network can cause damage to equipment (electrical plant, insulators, cables etc.). HV over-voltage protection devices (e.g. arc gaps, surge arresters etc.) are installed on 11kV and 6.6kV systems to help protect equipment from lightning. The attenuation of lightning impulses and the performance of over voltage protection is greatly improved by well designed, low impedance earthing systems.

Earthing conductor associated with surge arresters and triggered arc gaps should, as far as possible, provide a straight path for current to flow into the ground. Every bend increases the inductance of the earthing conductor which, in turn, gives rise to high impedance for high frequency impulses, such as lightning. In addition, for high frequency impulses, the vast majority of current flows into the ground via earth electrode installed within just a few meters of the equipment and electrode installed further away has little impact. In order to minimise voltage rise caused by lightning it is necessary to make use of both vertical and horizontal earth electrode installed close to the equipment.

4 ELECTRODE DESIGN

4.1 Maximum Resistance

4.1.1 11kV and 6.6kV

The resistance of 11kV and 6.6kV earthing systems shall, as far as reasonably practicable, be no higher than:

- 20 ohms for 11kV earthing systems.
- 15 ohms for 6.6kV earthing systems.

It is recognised that at some sites with particularly high soil resistivity it may not be reasonably practicable to satisfy the above criteria. This is deemed to be the case where the electrode extends for a distance of 200m or more from the installation without reaching the required resistance. In such cases an earth resistance of up to 40 ohms may be accepted as long as the equipment is protected by sensitive earth fault (SEF) protection. In Peterson Coil earthed systems the SEF protection only has to be in service when the Peterson Coil is shorted.

4.1.2 Low Voltage (LV)

LV Earthing Systems

The resistance of LV earthing systems shall be:

- No higher than the maximum allowable resistance for the associated HV earthing system (see 4.1.1) and;
- No higher than 20 ohms where PME or PNB earth terminals are to be made available.

PME Earth Electrodes

The earth resistance of individual PME earth electrodes shall be 100 ohms or less.

4.2 Thermal Requirements

As fault current flows through earth conductor and electrode into the ground it heats the conductor and dries out the soil around the electrode (increasing earth resistance). The conductor itself must be capable of withstanding this flow of current without damage and the surface area of the earth electrode must be large enough to prevent the ground drying out appreciably.

4.2.1 Conductor Fault Ratings

The method for calculating fault ratings of earth conductors is specified in 7.1. In practice, standard earthing system designs described below are suitable as long as the following minimum conductor sizes are used:

- 35mm² Copper PVC/PVC
- 70mm² Copper (bare electrode)
- 25mm x 3mm (bare earth strip)
- 12.5mm diameter copper clad steel earth rods
- 15mm diameter copper earth rods

It should be noted that bare earth electrode with a cross-sectional area of at least 70mm² is specified to provide sufficient surface area in contact with the ground, not for fault rating requirements (see 4.2.2).

4.2.2 Surface Area Requirements

The surface area of 11kV and 6.6kV earthing electrode in contact with the ground must be sufficiently large to prevent the ground drying out as fault current flows from the electrode into the ground. This prevents the resistance of the earthing system increasing unduly during the fault. Further information on calculating the required surface area is included in 7.1.

Where equipment is connected to an HV cable system and there is a continuous path for earth fault current to flow (i.e. down cable sheaths) all the way back to the primary substation only a small proportion of earth fault current will flow into the ground via the earth electrode. In such cases the surface area requirement is automatically satisfied by all the standard electrodes described in Table 3.

Where equipment is connected via an overhead line (with no earth wire) there is no continuous metallic path for earth fault current to flow back to the primary substation. In these circumstances the surface area requirements often dictate the length and arrangement for the electrode (see 4.4.2).

4.3 Location of Earth Electrode

Earth electrode shall be located and designed to:

- minimise risk from step, touch and transfer potentials.
- minimise likelihood of subsequent damage to the earthing system.
- make use of lower resistivity soil.
- make use of softer ground that will ease installation.

Bare earth electrode shall, as far as possible, not be laid in areas where people may reasonably be barefoot (e.g. near swimming pools, across caravan sites and gardens etc.).

11kV and 6.6kV earth electrode shall be segregated by at least:

- 9m from Swimming pools (and other areas where people may reasonably be barefoot).
- 9m from ponds/lakes used for commercial fish farming.
- 10m from BT telephone exchanges.
- 10m from railway installations.
- 9m from LV earth electrode, buildings and buried metalwork (e.g. lightning rods), where the 11kV or 6.6kV electrode is associated with a hot site.

Similarly, LV earth electrode and individual PME earth electrodes shall be segregated by at least:

- 10m from overhead line towers (pylons).
- 9m from HV earth electrode.
- 9m from hessian sheathed HV cables or from earth electrode bonded to an HV cable sheath (sometimes carried out at an HV joint) where the cable is connected to a hot site.

Segregation is achieved either by physically burying the LV electrode away from the HV equipment / installation or by using PVC (or equivalent) insulated conductor in the areas where the above distances are infringed.

In practice, these requirements can severely restrict location of earthed HV equipment. For example, hot substations cannot normally be installed within 9m of a steel framed building.

4.4 Standard Earth Electrode Arrangements

4.4.1 Individual PME Earth Electrodes

In relatively low resistivity soil of 200 ohm.m or less, an adequate individual PME earth electrode, with a resistance of up to 100 ohms, can be achieved by either installing a single 3m vertical earth rod (i.e. two 1.5m earth rods joined together) or by laying a 3m length of bare 70mm² copper conductor. For higher soil resistivities a more elaborate arrangement is required.

Table 1 and Table 2 list the expected earth resistance afforded by horizontal conductor and single vertical earth rods. The shaded areas indicate arrangements that do not satisfy the earth resistance requirement for an individual PME earth electrode. There is no minimum surface area requirement for individual PME earth electrodes.

Table 1: Resistance of a Horizontal PME Electrode (Laid 500mm Below the Surface in Uniform Soil)

Electrode Length (m)	Resistance (ohms)		
	Soil Resistivity 100 ohm.m	Soil Resistivity 300 ohm.m	Soil Resistivity 1000 ohm.m
1	87	260	867
2.5	44	131	437
5	26	77	257
10	15	45	149
15	11	32	108
20	9	26	85

Table 2: Resistance of a Single Vertical PME Earth Rod (in Uniform Soil)

Rod Length (m)	Resistance (ohms)		
	Soil Resistivity 100 ohm.m	Soil Resistivity 300 ohm.m	Soil Resistivity 1000 ohm.m
1.5	58	174	579
3	33	100	332
4.5	24	71	238
6	19	56	187
7.5	16	47	155
9	13	40	133
10.5	12	35	116
12	10	31	104
13.5	9	28	94
15	9	26	86

4.4.2 Standard Earth Electrode Arrangements

Three generic earth electrode layouts have been developed covering a variety of soil conditions. These arrangements form the basis for earthing 11kV, 6.6kV and LV plant, equipment and poles mounted equipment. Details of each arrangement are provided in Table 3 and in Figure 2, Figure 3, Figure 4 and Figure 5.

HV earthing systems and combined HV / LV earthing systems that are connected to HV surge arresters or to HV equipment with arc gaps (i.e. triggered arc gaps or duplex arc gaps) must be suitable for lightning protection. In these circumstances additional earth rods or additional electrode laid in a tee or star configuration must be installed as close as reasonably practicable to the surge arresters / equipment. These requirements are shown in Figure 6 and Figure 7.

Table 4 gives the expected earthing resistance for a variety of soils with uniform resistivity. In most cases soil resistivity will vary at different soil depths and will also vary along the length of the electrode and therefore, in practice, resistances are likely to vary somewhat from the values given.

The shaded areas in Table 4 only apply to HV earth electrodes and combined HV and LV earth electrodes and denote electrodes that have insufficient surface area to prevent the ground drying out around the electrode. This requirement is only relevant where there is not a continuous metallic path (e.g. via cable sheaths / screens) back to the primary substation.

Soil resistivity values can be obtained by measurement (in accordance with ST: TP210), or can be estimated, based on local knowledge. A certain amount of information can also be gleaned from British Geological Survey maps but these can be difficult to interpret. Section 7.3 provides a list of typical soil resistivities for a number of soil / rock types. It is recommended that records of soil resistivity measurements are kept by the local office so that a picture of the soil resistivity in the area can be built up.

The Planner should select the required earthing arrangement and estimate the length of electrode to satisfy resistance and thermal requirements at the design stage (see 4.1 & 4.2). The electrode arrangement, required earth resistance and estimated minimum length requirements should be specified on construction drawings.

Earth electrode resistance is proportional to soil resistivity (in uniform soil), and so, Table 4 can also be used during the construction phase to calculate the actual soil resistivity using the following formula:

$$\rho_{\text{actual}} = \frac{\rho_{\text{estimated}} \times R_{\text{actual}}}{R_{\text{estimated}}}$$

- | | | |
|---------------------------|---|---|
| ρ_{actual} | = | actual soil resistivity |
| $\rho_{\text{estimated}}$ | = | soil resistivity estimated at design stage |
| R_{actual} | = | measured earth electrode resistance |
| $R_{\text{estimated}}$ | = | earth electrode resistance estimated from Table 4 |

Where onerous conditions are found advice may be sought from Primary System Design who can, if necessary, carry out site-specific earthing designs.

Worked Example 1: Determining Minimum Electrode Length

A Planner assumes the soil resistivity to be 100 ohm.m, specifies Arrangement B and estimates that 30m length of electrode will be required (to satisfy surface area requirements). This length of electrode should, according to Table 4, achieve a resistance of 4.3 ohms.

In practice, when the electrode is actually installed the construction team measure a resistance of 9.5 ohms. From the above formula the actual soil resistivity is:

$$\rho_{\text{actual}} = 100 \times 9.5 / 4.3 = 221 \text{ ohm.m}$$

The installer then uses the 300 ohm.m section of Table 4 to determine the minimum length of electrode. It can be seen that 40m of electrode is required for to satisfy the surface area requirements and so the installer must extend the electrode by a further 10m.

Table 3: Generic Earth Electrode Arrangements

Arrangement	Description and Application	Diagram
A	Horizontal electrode with 3m earth rods spaced at 3m intervals. Installation of 3m earth rods requires favourable soil conditions.	Figure 2
B	Horizontal electrode and 1.5m earth rods spaced at 1.5m intervals. 1.5m earth rods allow installation in less favourable soil conditions than arrangement 1	Figure 3
C	Horizontal electrode with a single earth rod. Suitable where underlying rock prevents installation of multiple earth rods.	Figure 4
D	Three parallel horizontal electrodes with a single earth rod. Suitable where underlying rock prevents installation of multiple earth rods and where space restrictions prevent the use of arrangement C.	Figure 5

Table 4: Resistance of Earth Electrodes in Uniform Soil

Horizontal Length of Electrode (m)	Resistance of Earth Electrode System (Ω)			
	Arrangement A	Arrangement B	Arrangement C	Arrangement D
Soil Resistivity 100 Ohm.m				
20	5.2 ^[1]	5.8 ^[1]	8.0 ^[1]	8.0 ^[1]
30	3.8	4.3	5.8 ^[1]	5.8
40	3.1	3.5	4.5 ^[1]	4.5
50	2.6	2.9	3.8 ^[1]	3.8
75	1.9	2.1	2.7 ^[1]	2.7
100	1.5	1.7	2.1	2.1
125	1.3	1.4	1.7	1.7
150	1.1	1.2	1.5	1.5
175	1.0	1.1	1.3	1.3
200	0.9	1.0	1.2	1.2
Soil Resistivity 300 Ohm.m				
20	15.6 ^[1]	17.3 ^[1]	24.1 ^[1]	24.1 ^[1]
30	11.3 ^[1]	12.8 ^[1]	17.3 ^[1]	17.3
40	9.3	10.4	13.6 ^[1]	13.6
50	7.9	8.7	11.3 ^[1]	11.3
75	5.7	6.3	8.0 ^[1]	8.0
100	4.6	5.1	6.3	6.3
125	3.9	4.2	5.2	5.2
150	3.3	3.6	4.5	4.5
175	2.9	3.2	3.9	3.9
200	2.7	2.9	3.5	3.5
Soil Resistivity 1000 Ohm.m				
20	52.2 ^[1]	57.5 ^[1]	80.4 ^[1]	80.4 ^[1]
30	37.7 ^[1]	42.5 ^[1]	57.6 ^[1]	57.6
40	30.9 ^[1]	34.7 ^[1]	45.4 ^[1]	45.4
50	26.4 ^[1]	29.1 ^[1]	37.7 ^[1]	37.7
75	19.0	21.1	26.8 ^[1]	26.8
100	15.3	16.9	21.0 ^[1]	21.0
125	12.8	14.1	17.4 ^[1]	17.4
150	11.0	12.1	14.9	14.9
175	9.7	10.7	13.0	13.0
200	9.1	9.5	11.6	11.6

Note 1: The shaded area of the table denotes arrangements that have insufficient surface area to prevent the soil drying out under fault conditions. This surface area requirement only applies to HV earth electrodes (and combined HV & LV electrodes) where there is not a continuous cable back to the primary substation. See section 4.2.2 for further guidance.

Figure 2: Earth Electrode Arrangement A

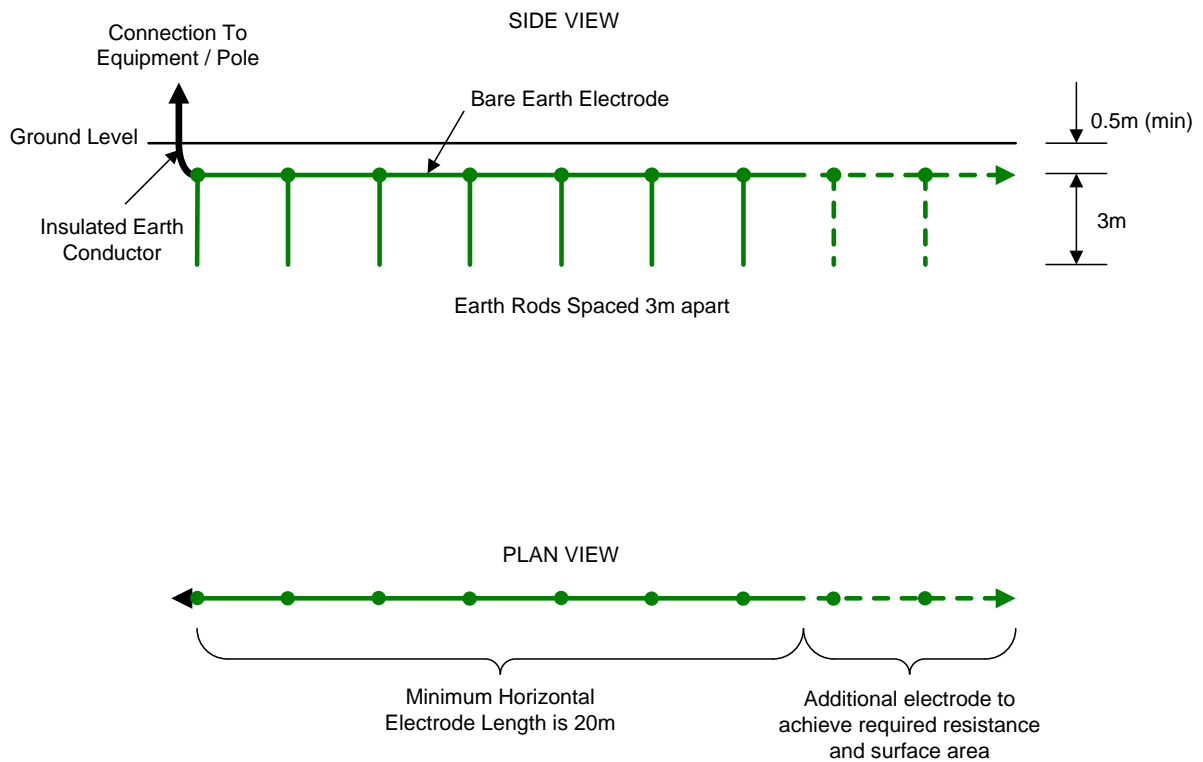

Note 1: 3m spacing between earth rods.

Note 2: Minimum horizontal length of electrode is 20m (assuming resistance and surface area requirements are satisfied).

Note 3: Bare horizontal earth electrode comprises 70mm² (min.) copper conductor.

Note 4: Vertical earth rods comprise either copper clad steel (12.5mm diameter min.) or copper (15mm diameter min.).

Note 5: Earth conductor connected to the electrode comprises 35mm² PVC/PVC (min.).

Note 6: Minimum electrode depth is 0.5m in non-agricultural land and 1.0m in agricultural land.

Figure 3: Earth Electrode Arrangement B

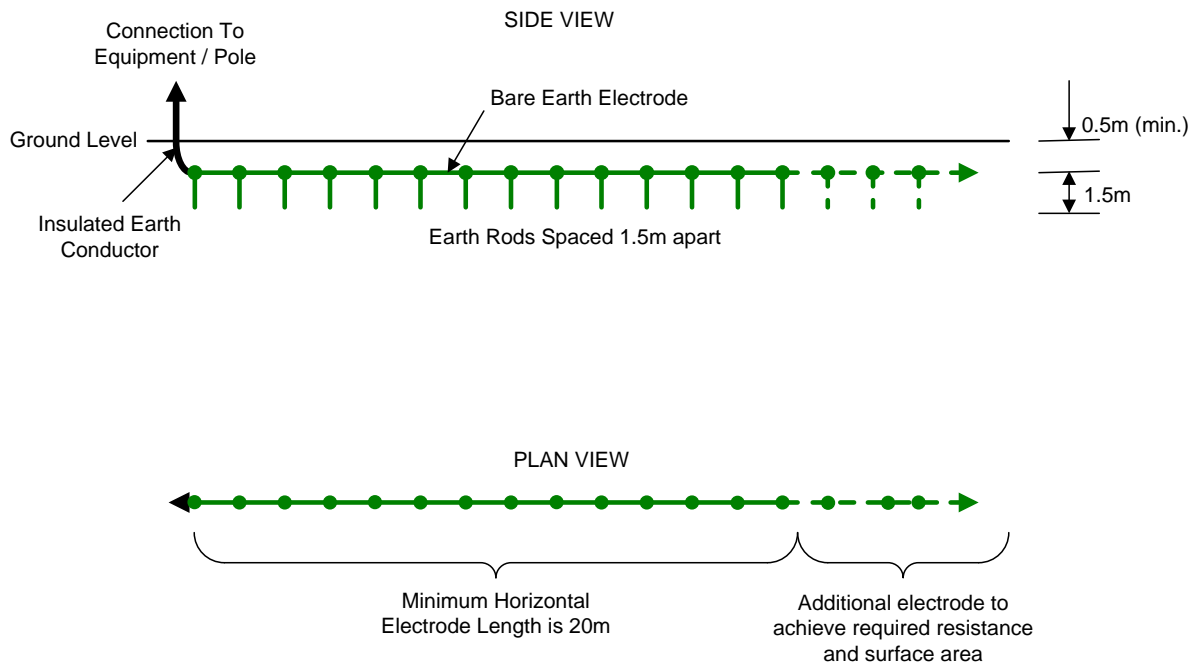

- Note 1: Minimum horizontal length is 20m (assuming resistance and surface area requirements are satisfied).
- Note 2: Bare earth electrode comprises 70mm² (min.) copper conductor.
- Note 3: Earth rods comprise of either copper clad steel (12.5mm diameter min.) or copper (15mm diameter min.).
- Note 4: Earth conductor connected to the electrode comprises 35mm² PVC/PVC (min.).
- Note 5: Minimum electrode depth is 0.5m in non-agricultural land and 1.0m in agricultural land.

Figure 4: Earth Electrode Arrangement C

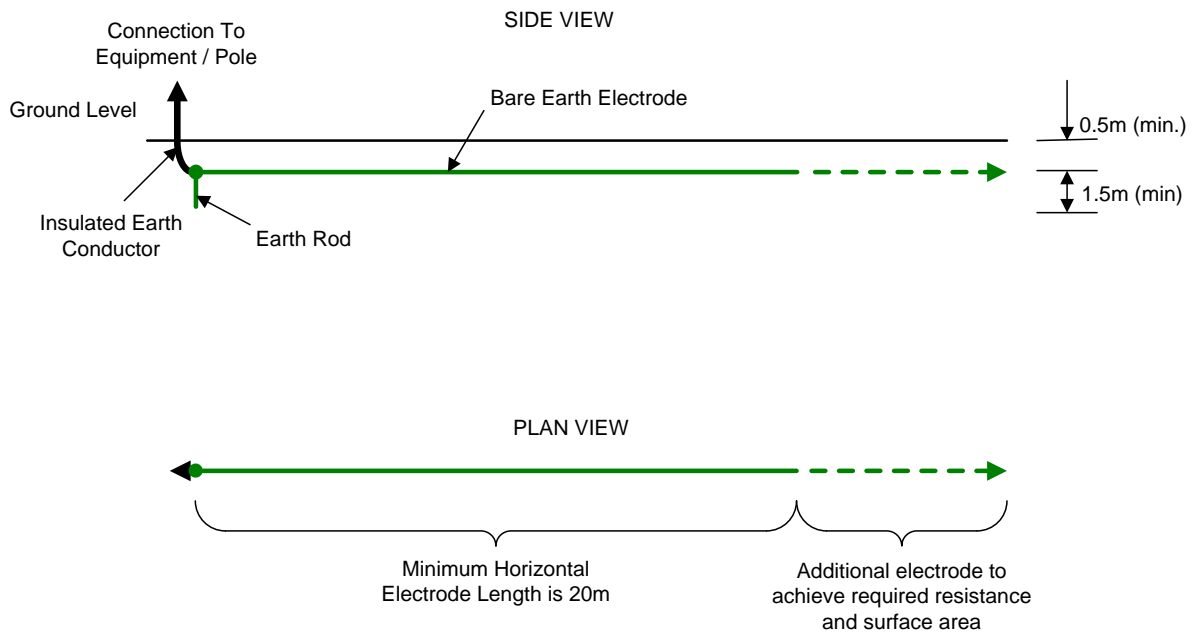

- Note 1: Minimum horizontal length is 20m (assuming resistance and surface area requirements are satisfied).
- Note 2: Bare earth electrode comprises 70mm² (min.) copper conductor.
- Note 3: Earth rod (either 12.5mm diameter copper clad steel or 15mm diameter copper) is installed if soil conditions permit.
- Note 4: Earth conductor connected to the electrode comprises 35mm² PVC/PVC (min.).
- Note 5: Minimum electrode depth is 0.5m in non-agricultural land and 1.0m in agricultural land.

Figure 5: Earth Electrode Arrangement D

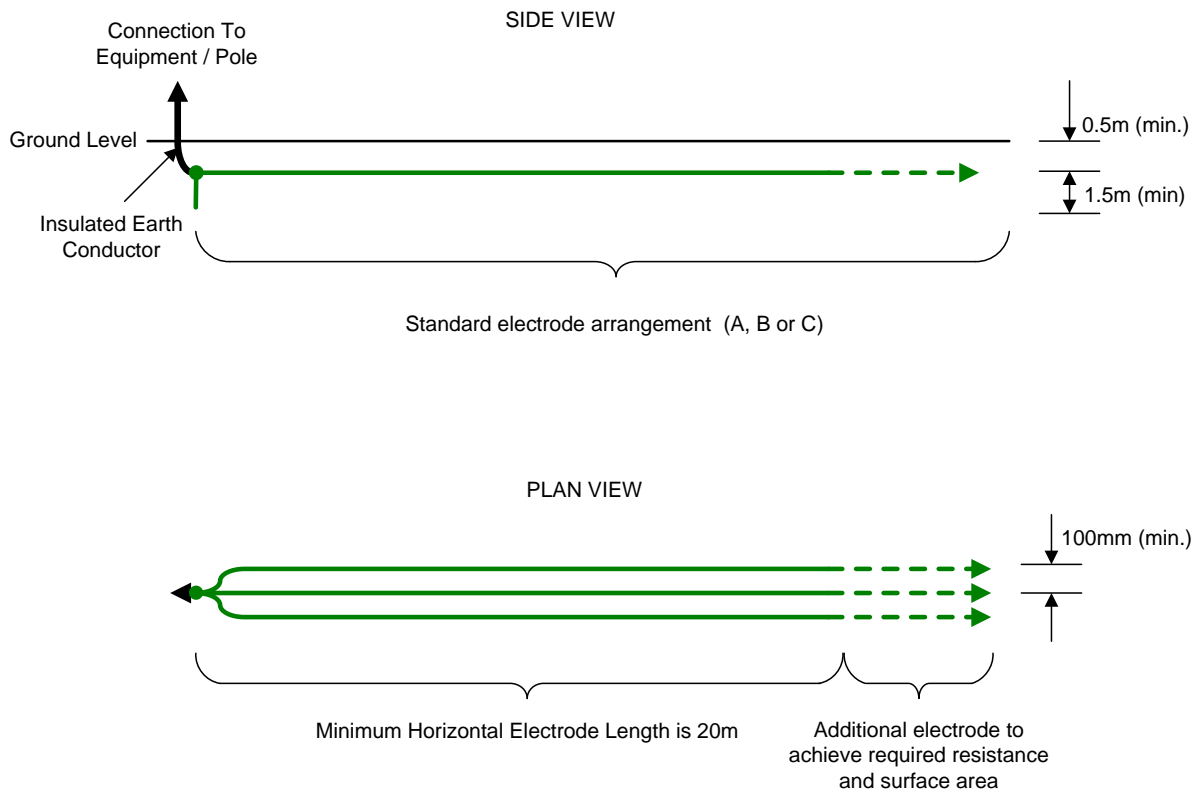

- Note 1: Minimum horizontal length is 20m (assuming resistance and surface area requirements are satisfied).
- Note 2: Bare earth electrode comprises 70mm² (min.) copper conductor.
- Note 3: Earth rod (either 12.5mm diameter copper clad steel or 15mm diameter copper) is installed if soil conditions permit.
- Note 4: Earth conductor connected to the electrode comprises 35mm² PVC/PVC (min.).
- Note 5: Minimum electrode depth is 0.5m in non-agricultural land and 1.0m in agricultural land.
- Note 6: Minimum separation between parallel electrodes is 100mm.

Figure 6: Additional Requirements for HV Lightning Protection (1st Choice)

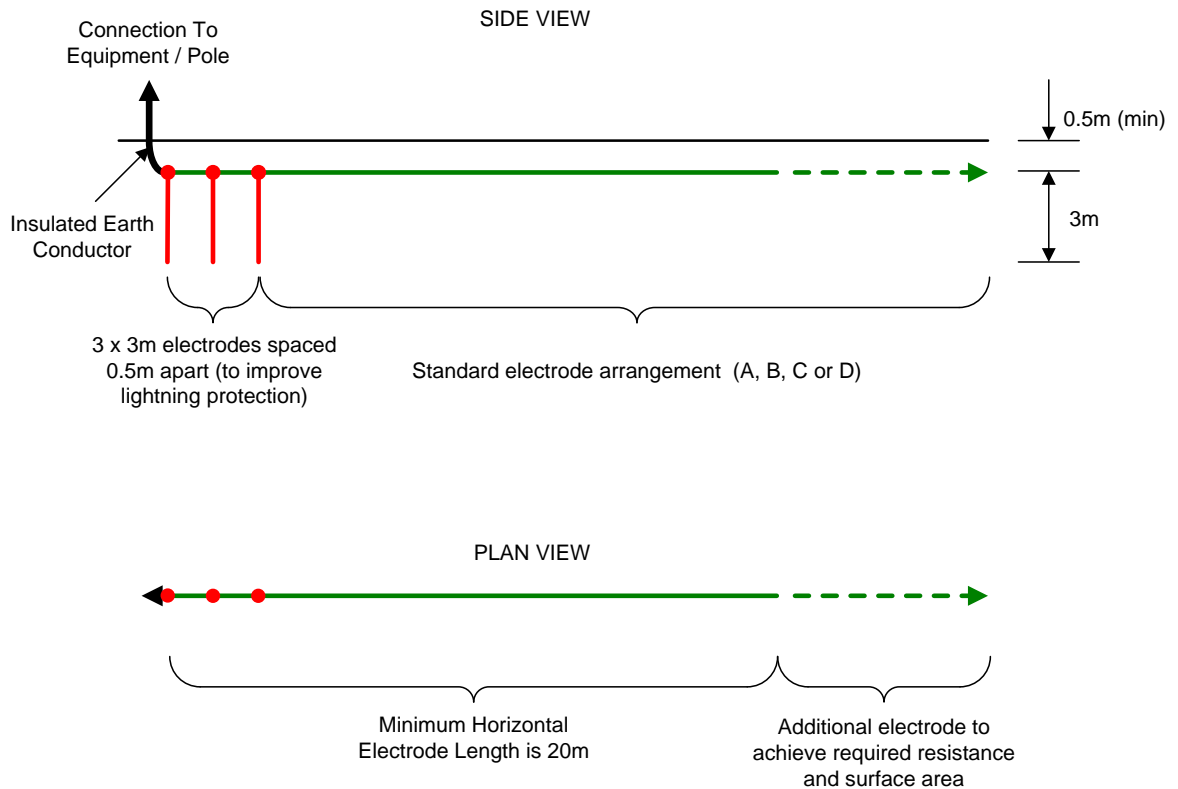

- Note 1: This drawing is only applicable to HV earth electrodes and combined HV/LV electrodes that need to be optimised for lightning protection (see 0 for application).
- Note 2: This option is preferred where ground conditions allow earth rods to be installed.
- Note 3: Drawing should be read in conjunction with Figure 2, Figure 3, Figure 4 or Figure 5, as appropriate.
- Note 2: Three earth rods (preferably 3m in length) are installed at the origin of the earth electrode.
- Note 3: Earth rods comprise of either copper clad steel (12.5mm diameter min.) or copper (15mm diameter min.).

Figure 7: Additional Requirements for HV Lightning Protection (2nd Choice)

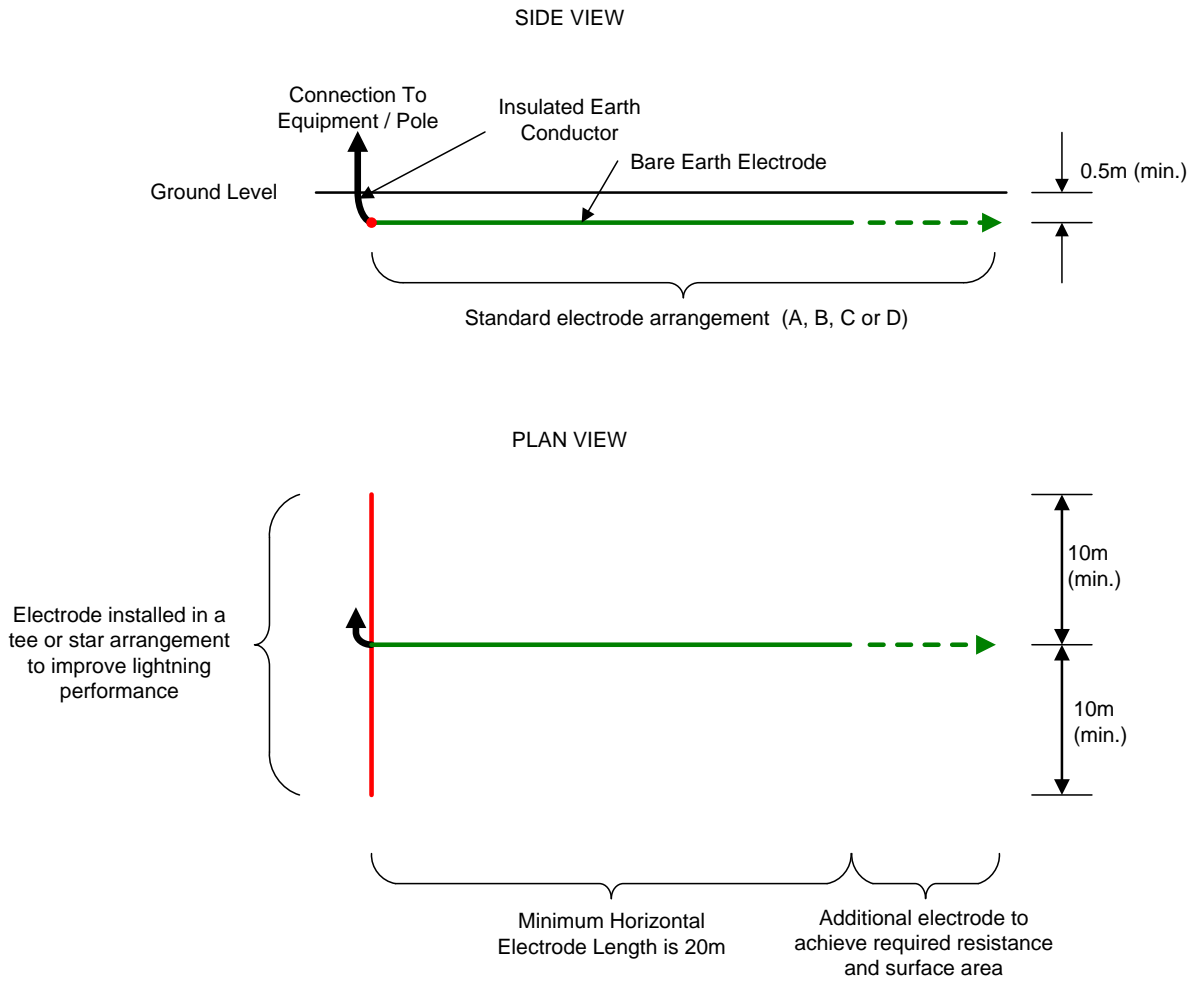

- Note 1: This drawing is only applicable to HV earth electrodes and combined HV/LV electrodes that need to be optimised for lightning protection (see 0 for application).
- Note 2: This option may be used where ground conditions preclude the installation of earth rods (see Figure 5).
- Note 3: Drawing should be read in conjunction with Figure 2, Figure 3, Figure 4 or Figure 5, as appropriate.
- Note 4: Additional 70mm² (minimum) copper conductor is laid in a tee or star arrangement at the origin of the earth electrode.

5 11KV AND 6.6KV EARTHING

5.1 System Earthing

Western Power Distribution's 11kV and 6.6kV systems are earthed exclusively at source primary substations and protection systems are designed and set accordingly. The only exception to this rule is the earthing of 5 limb VTs, as described below.

11kV and 6.6kV customer systems shall not introduce additional earths to Western Power Distribution's 11kV and 6.6kV system.

5 limb voltage transformers (VTs), typically used for protection such as neutral voltage displacement, directional earth fault or distance protection, must have their HV winding earthed in order to function correctly. They inherently have a high impedance and so do not significantly affect the flow of current under earth fault conditions.

5.1.1 Earthing Arrangements

A number of different system earthing devices and methods are currently used at primary substations. Of these methods, two systems are preferred, reactance earthing and Peterson coil earthing (also known as arc suppression coil or ASC earthing).

Peterson Coil earthing is predominantly used within Cornwall and on the Gower Peninsula. In all other areas reactance or resistance earthing is predominantly used.

Solid Earthing

Solid earthing is only used where the source impedance of the network restricts earth fault current to below 3500A on the 11kV or 6.6kV system. This is often the case at single transformer primary substations. See Figure 8.

Figure 8: Solid Earthing

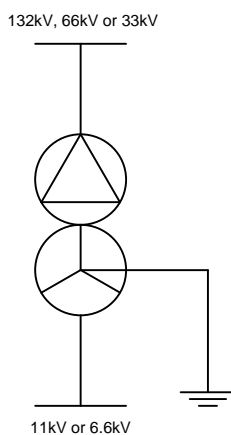

Resistance and Reactance Earthing

Earthing reactors and earthing resistors (e.g. liquid earthing resistors) are commonly used to limit earth fault current. At new or substantially modified installations each primary transformer is connected to earth through a separate earthing device, although at some existing sites earthing devices are shared between two or more transformers. Standard resistor and reactor ratings are given below:

- Earthing Reactor – 1250A (5.08 ohms for 11kV systems and 3.05 ohms for 6.6kV systems)
- Earthing Resistor – 1000A (6.35 ohms for 11kV systems and 3.84 ohms for 6.6kV systems)

These standard values are chosen to restrict earth fault current to acceptable levels whilst still allowing sufficient earth fault current to operate protection quickly and decisively. Alternative resistance and reactance values may be used where appropriate. See Figure 9 and Figure 10.

Figure 9: Reactance Earthing

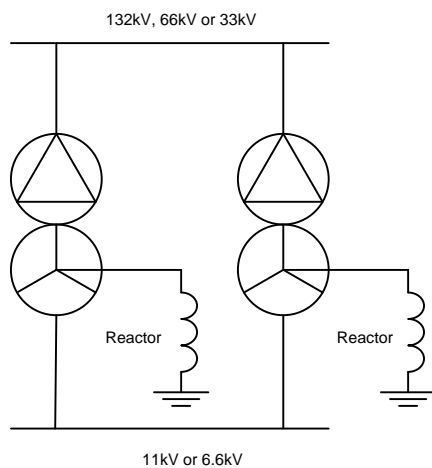
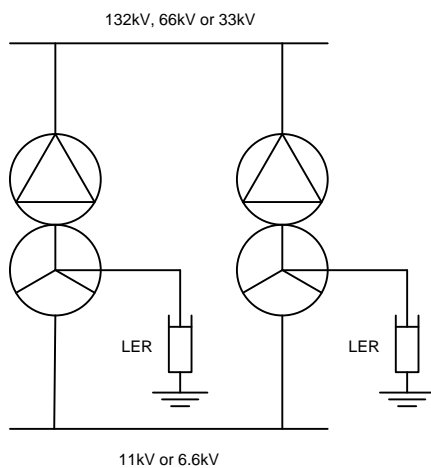

Figure 10: Resistance Earthing



Peterson Coil Earthing

Peterson coils are commonly used within overhead networks in Cornwall and on the Gower Peninsula in South Wales and may be used in other areas, where appropriate. All the primary transformers are connected to earth via one (or more) Peterson coil. The reactance of the Peterson coil is tuned (manually or automatically) to closely match the capacitance of the connected network, reducing earth fault current to a negligible level. When an earth fault occurs it is typically held on the coil (i.e. the fault is not cleared) whilst it is located.

Peterson coil shorting arrangements are typically provided to connect the substation to solid earth for maintenance purposes or to allow earth faults to be cleared automatically by protection. See Figure 11.

In some cases the installation may be designed to switch to reactance or resistance earthing (rather than solid earthing). This helps to reduce the rise of earth potential experienced should an earth faults occur with the Peterson coil out of service. See Figure 12.

Figure 11: Peterson Coil Earthing with Shorting Switch

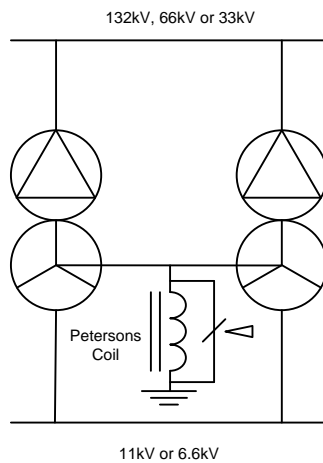
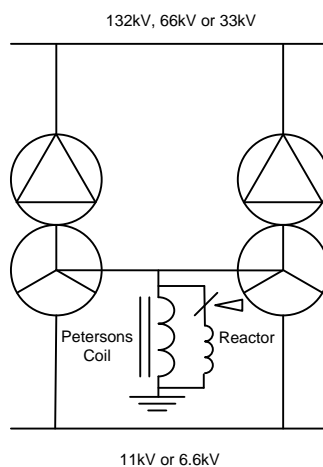

Figure 12: Peterson Coil Earthing with Alternative Reactance Earthing



Note: Additional switches, required for maintenance / operational requirements are not shown on these drawings.

Earthing Transformers

Where the 11kV or 6.6kV winding of a primary transformer has no earth connection (e.g. delta winding) the 11kV system is earthed via earthing transformers. In some cases the earthing transformers are designed to have a high impedance that restricts the earth fault current to acceptable levels (Figure 13) or alternatively where they have a low impedance they are connected to earth via additional earthing resistors or reactors (Figure 14). One earthing transformer and, where necessary one earthing resistor or reactor is installed per transformer.

Figure 13: High Impedance Earthing

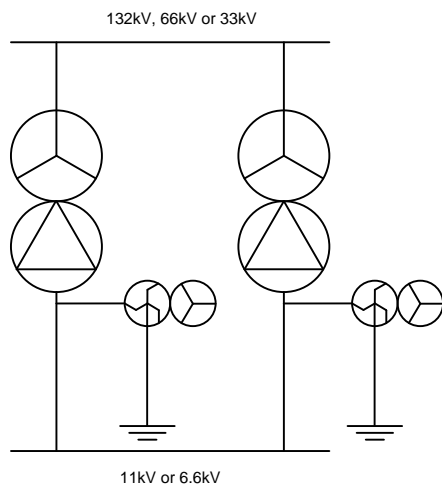
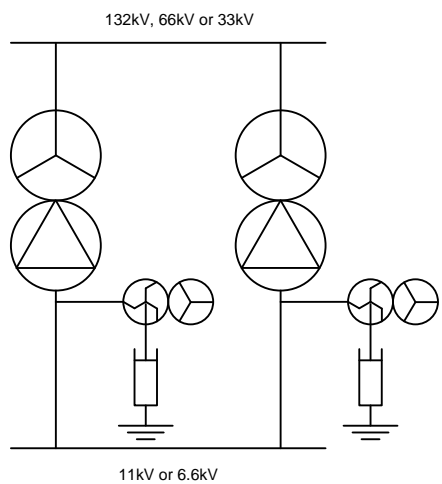

Figure 14: Low impedance Earthing Transformer with Resistor or Reactor



5.2 Equipment Earthing

The following types of 11kV and 6.6kV equipment shall be connected to an HV earth electrode:

~~HV Ground Mounted Equipment~~

- ~~• Transformers and other associated metalwork~~
- ~~• Switchgear~~
- ~~• Reactors, capacitors / power factor correction equipment and filters~~
- ~~• Cable terminations~~

Pole Mounted Equipment

- Circuit breakers, sectionalisers and metal-clad switches that include cabinets etc. accessible from the ground.
- Circuit breakers, sectionalises and metal clad switches that do not have cabinets accessible from the ground, if required by the manufacturer or if other equipment on the pole requires earthing.
- Transformers
- Air break switch disconnectors (ABSDs) that have an operating handle accessible from the ground
- Auxiliary supply transformers
- Radio & SCADA control cabinets associated with the above equipment.
- Surge arresters
- Triggered arc gaps
- Cable terminations
- Sky cradles (i.e. earthed cradle beneath a road crossing)
- All steelwork and brackets etc. on poles fitted with the above equipment

5.3 Determining Whether a Distribution Substation is Hot or Cold

The process for determining whether or not a distribution substation is “hot” or “cold” is given in Figure 15 and is described below. In addition, a spreadsheet has been developed (available from the following link) that can be used to determine whether or not a site is hot.

\\avodcs01\technca\earthing\hot_site_calc.xls

The first stage is to determine whether or not there is a continuous metallic earth path between the distribution substation and the primary substation that normally feeds it. A continuous earth path can be assumed if a route comprising entirely of HV underground cable exists between the distribution substation and the primary substation.

Standard HV overhead line (2 or 3 wire) does not include an earth wire and therefore if one or more span of overhead line is inserted, this will break the metallic earth path.

If a continuous metallic earth path does exist, this will provide a relatively low impedance path for current to flow back to the primary substation when earth faults occur at a distribution substation, or on the associated HV cable network and hence rise of potential at the distribution substation will be minimised.

A continuous metallic earth path is also capable of transferring rise of potential that occurs at the primary substation (e.g. for earth faults that occur on the high voltage side of the primary transformers) back to the distribution substations. A more detailed explanation of this concept is described in 7.2.

5.3.1 Continuous Metallic Earth Path Between The Primary And Distribution Substations

The distribution substation is deemed to be “cold” if the primary substation is also “cold”.

The distribution substation may also be “cold” if the primary substation is hot but this depends on the rise of potential (ROP) at the primary substation and the length and type of cable feeding the distribution substation. Table 5 specifies the minimum cable length that is required in order for the distribution substation to remain “cold”.

Information on Hot Site/Cold Site classification, earth potential rise and earth resistance for substations with nominal voltage $\geq 33\text{kV}$ is available from Primary System Design.

Table 5: Distribution Substation fed via Cable from a Hot Primary Substation - Minimum HV Cable Length for Distribution Substation to be Classified as “Cold”

ROP at Primary S/S (V)	Minimum Cable Route for Site to be “Cold”(m)		
	Predominantly PILC Cable[1]	Mixed PILC and CAS / EPR Cable [2]	Predominantly CAS or EPR Cable [3]
500	300	400	600
600	800	900	1200
700	1200	1500	2000
800	1500	1800	3000
900	1600	2400	N/A ^[4]
1000	2000	3000	N/A ^[4]
>1000	N/A ^[4]	N/A ^[4]	N/A ^[4]

Note 1: Applies where 66% or more of the cable circuit consists of Paper Insulated Lead Covered (PILC) cable.

Note 2: Applies where between 33% and 66% of the cable route consists of PILC cable.

Note 3: Applies where less 33% or less of the cable route consists of PILC cable.

Note 4: All substations are deemed to be hot irrespective of the cable length.

Note 5: The cable lengths specified in this table assume that the earth resistance of each distribution substation (including fortuitous earthing from connected PILC cable, PME earths etc.), when considered in isolation from the rest of the network, is 10 ohms or less. Where this assumption is likely to be incorrect then further guidance shall be sought from the author.

5.3.2 Discontinuous Metallic Earth Path Between The Primary And Distribution Substations

If there is not a continuous metallic earth path between the primary and distribution substation the distribution substation is normally “hot”, unless the earth resistance at the distribution substation is particularly low.

A site specific calculation (formula is provided below) can be carried out to determine the rise of potential at the distribution substation. If this value is below 430V the site is “cold”. The calculation can also be carried out using the spreadsheet mentioned in 5.3, above.

$$V_{\text{ep}} = \frac{3ER_e}{\sqrt{(2R_1 + R_0 + 3R_e)^2 + (2X_1 + X_0)^2}}$$

Where:

- V_{ep}** Earth potential Rise at substation (V)
- E** Nominal system phase to earth voltage (V) (e.g. 6350V for the 11kV system and 3811V for the 6.6kV system)
- R₁** Positive phase sequence source resistance at distribution substation (ohms)
- X₁** Positive phase sequence source reactance at distribution substation (ohms)
- R₀** Zero phase sequence source resistance at distribution substation (ohms)
- X₀** Zero phase sequence source reactance at distribution substation (ohms)
- R_e** Earth electrode resistance at distribution substation (ohms)

Values for **R₁**, **X₁**, **R₀** and **X₀** can be obtained by running studies on WPDs HV power analysis software (e.g. Dinis) or failing this that can be provided by Primary System Design.

Figure 15: Process to Determine the Hot / Cold Status of a Distribution Substation

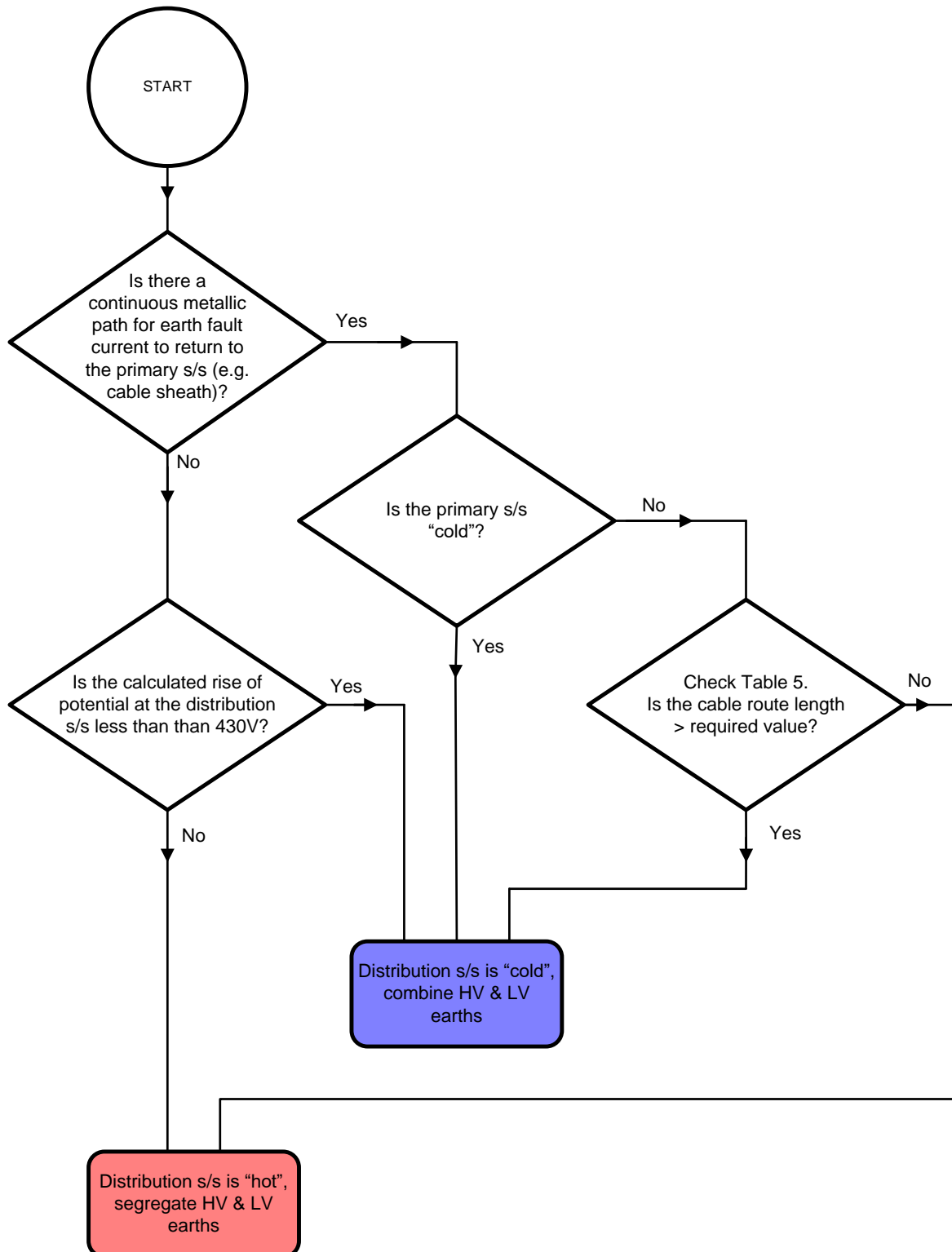

5.3.3 Worked Example 2: Determining Whether Substation Sites are Hot or Cold

Figure 16 shows a mixed 11kV network comprising of 3 wire overhead line and 3 core underground cable. The overhead line (3 wire wood pole line) does not include an earth wire, whilst the cable sheath is continuous and earthed at the primary substation. The 33/11kV Primary Substation feeding this network is “hot” and can experience a rise of potential as high as 590V (e.g. when a 33kV fault thrower operates).

Figure 16: Mixed 11kV Network For Worked Example 2

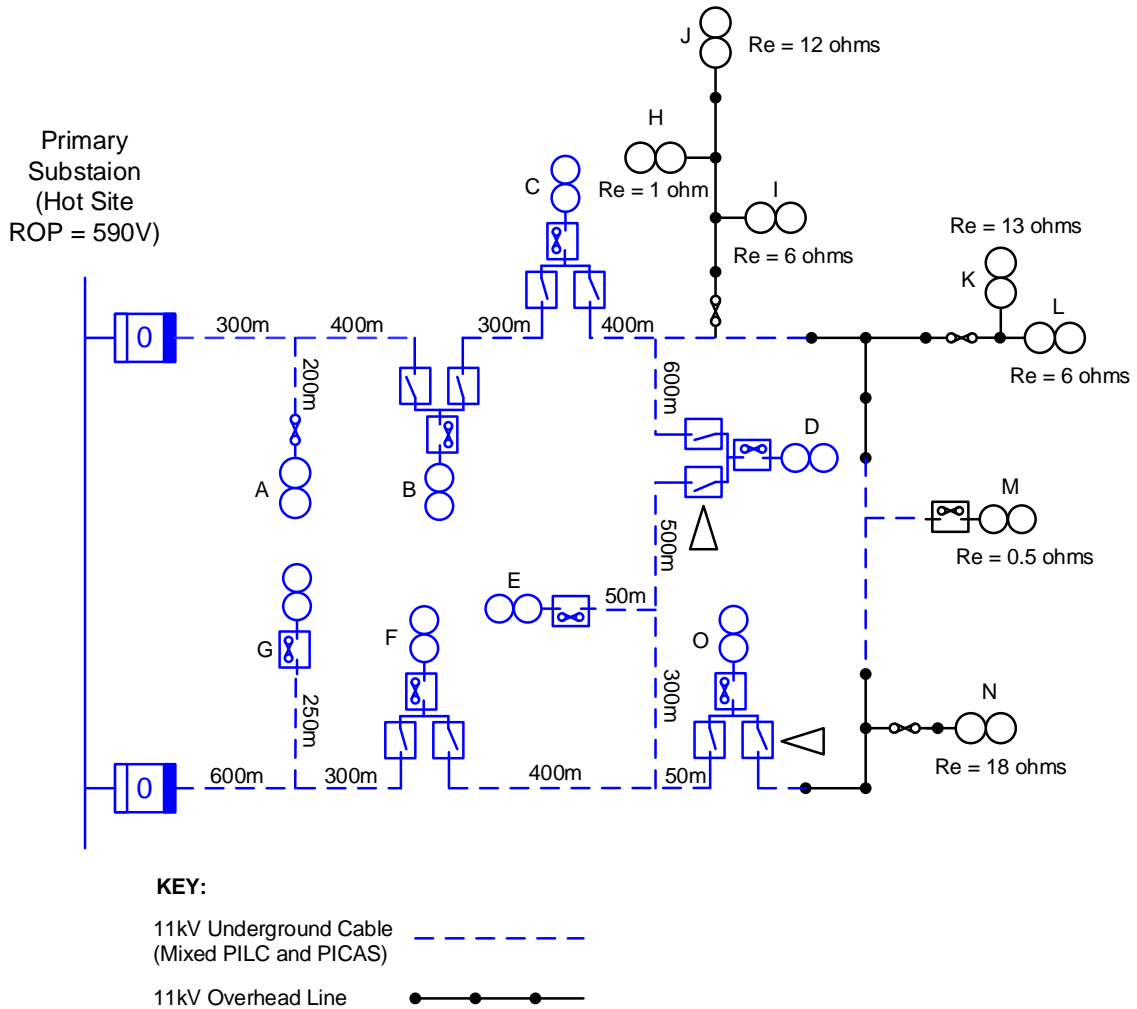

Substation A, B, C, D, E, F, G and O all have a continuous metallic path back to the primary substation (i.e. cable sheath) via their normal feeding arrangement. The rise of earth potential at the primary substation is 590V and can be transferred to the distribution substations. From Table 5 it is found that the minimum cable length (for mixed PILC and PICAS cable) that is required to make the substations cold is 900m. This means that substations C, D, E and F can be considered to be cold. These results are summarised in Table 6.

Table 6: Classification of Cable Connected Substations For Worked Example 2

Distribution S/S	Actual Cable Length – Primary to Distribution S/S (m)	Classification
A	500	Hot
B	700	Hot
C	1000	Cold
D	2000	Cold
E	1650	Cold
F	900	Cold
G	850	Hot
O	1350	Cold

Note: For a 590V ROP and mixed PILC and PICAS cable the cable route between the distribution s/s and primary must be at least 900m for the site to be considered cold.

Substation H, I, J, K, L, M and N are all fed via overhead line and therefore a calculation is needed to determine whether they are “hot” or “cold”. Table 7 lists the source impedance data for each substation and the actual earthing resistance at each site. The rise of earth potential is calculated using the formula specified earlier in this section (or by using the hot site, calculation spreadsheet). It can be seen that only substation M has a rise of earth potential below 430V and is “cold”. All the other substations (H, I, J, K, L and N) are “hot”.

Table 7: Earth Potential Rise Calculations For Worked Example 2

S/S Ref	R ₁ (ohms)	X ₁ (ohms)	R ₀ (ohms)	X ₀ (ohms)	Required value of R _e for “cold” site (ohms)	Actual value of R _e (ohms)	V _{epr} (V)	S/S Status
H	0.61	1.59	11.77	11.18	0.45	1	887	hot
I	0.49	1.27	9.42	8.94	0.36	6	3732	hot
J	0.91	2.31	17.71	16.52	0.68	12	3848	hot
K	0.73	1.83	13.91	13.36	0.54	13	4347	hot
L	0.76	1.99	14.71	14.03	0.57	6	2956	hot
M	0.85	2.23	16.48	15.6	0.64	0.5	339	cold
N	0.89	2.30	17.05	16.25	0.66	18	4527	hot

5.4 Distribution Substations – General

Earthing requirements for distribution substations (with exception of those used to provide supplies to Major Substations and to equipment fixed to high voltage structures, e.g. HV poles and pylons) are specified below. These two exceptions are covered in ST: TP21B and ST: SD6E, respectively.

All metalwork associated with distribution substations (e.g. transformer, switchgear and LV cabinet metalwork) must be connected to a locally installed HV earthing system.

The transformer's LV neutral shall be directly connected to an LV earthing system.

LV and HV earth electrodes may be combined together if the site is deemed to be "cold" (see definition in Section 2).

Where sites are "hot" HV and LV electrodes must be segregated by at least 9m. If a 9m segregation distance is not achievable (e.g. where the substation already exists) an individual assessment may be conducted, taking account of the actual rise in potential and earth electrode arrangement, to determine the required segregation distance.

5.5 Distribution Substations - Combined HV and LV Earthing

Where there is a continuous metallic path (i.e. continuous cable) back to the primary substation the minimum acceptable horizontal length of buried earth electrode is 20m, although it is recommended that a longer horizontal length of electrode (up to approximately 50m) is installed where this can be carried out easily and cost effectively.

~~5.5.1 Ground Mounted and Pad Mounted Substations~~

~~Requirements for combined HV and LV arrangements are shown in Figure 17 and Figure 18 and are listed below:~~

- ~~• The earth electrode design is selected from the standard arrangements A, B, C or D (see Table 3).~~
- ~~• LV cabinet link, between the HV earth bar and the LV neutral earth bar, shall be connected.~~
- ~~• Where necessary a separate substation earth bar may be installed to enable multiple earth connections to be made.~~
- ~~• HV cable sheaths shall be bonded directly to the HV earthing system (it is not acceptable to rely on a fortuitous connection through HV metalwork).~~
- ~~• Where an HV metering unit is installed this shall be bonded to the HV earthing system (it is not acceptable to rely on a fortuitous connection through HV metalwork).~~
- ~~• The first section of HV electrode shall be buried immediately in front of the HV switchgear to help reduce touch potentials (potential difference between hands and feet) for switchgear operators.~~

- ~~An LV socket may be provided within the LV cabinet.~~
- ~~LV substation auxiliary supplies (e.g. for lighting, sockets etc.) shall be derived from a suitably fused terminal blocks located within the LV cabinet. Such wiring shall satisfy the requirements of BS 7671 (IET Wiring Recommendations). It is recommended that auxiliary circuits that supply a.c. sockets within the substation are protected by a type A RCD (residual current device) unless they also supply essential safety related equipment (such as protection or fire alarm / fire fighting equipment).~~
- ~~Pad mounted transformers may be installed without additional fences or enclosures where security risks are low and they are deemed to be aesthetically acceptable.~~
- ~~Further information on substation fencing is provided in 5.7.~~

Figure 17: Combined HV/LV Earthing at Unit Type Ground Mounted & Pad Mounted Distribution Substations

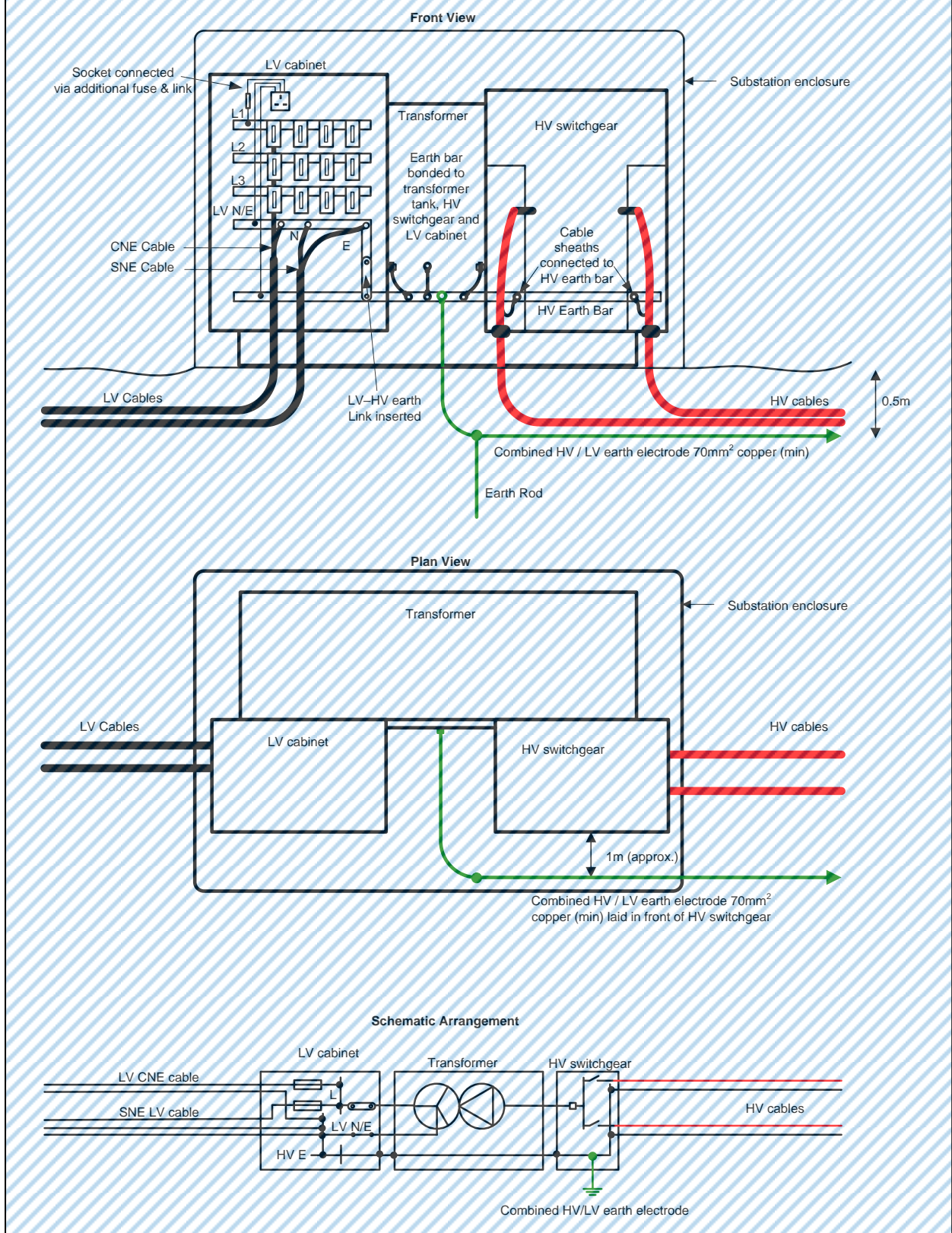
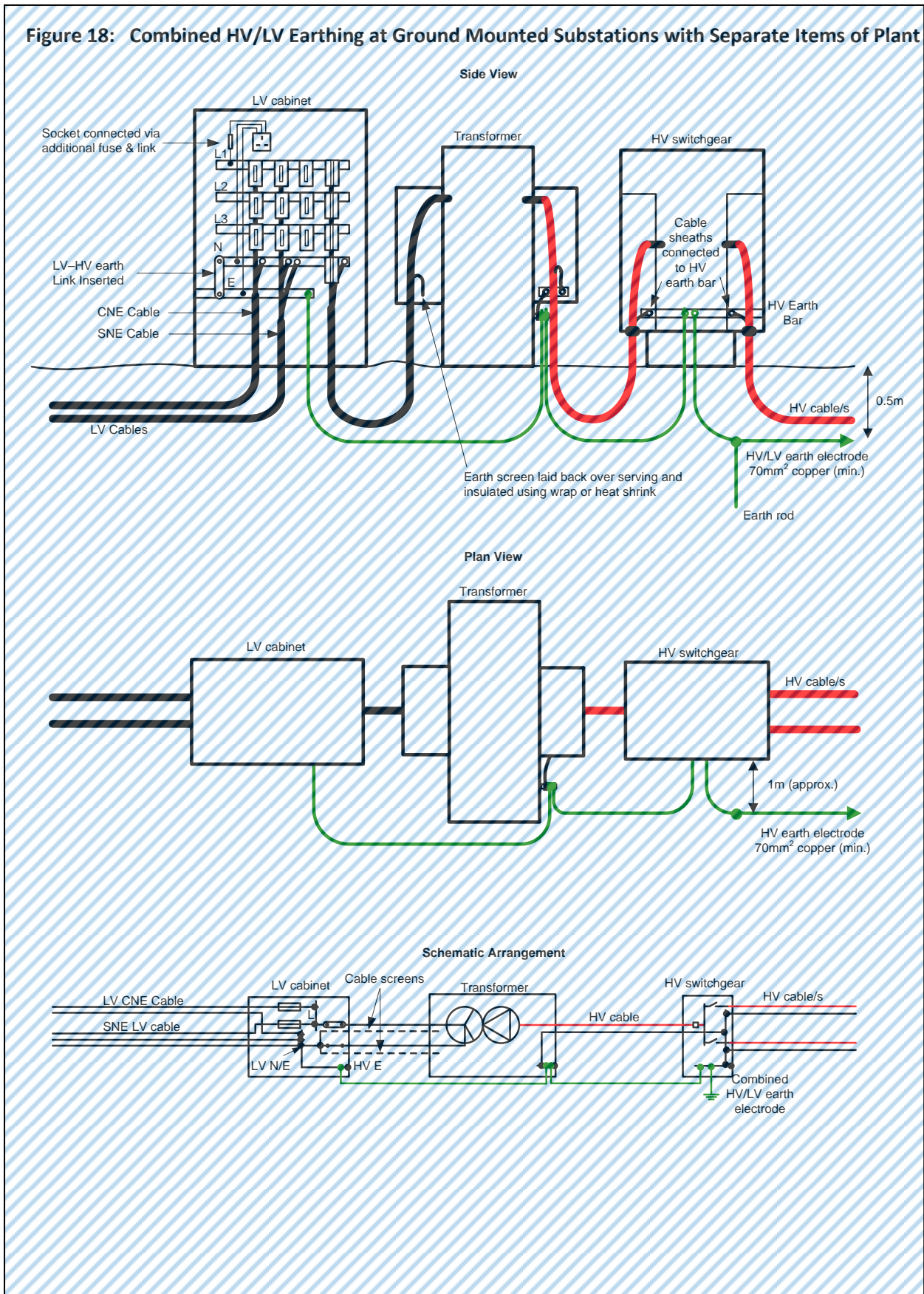

Figure 18: Combined HV/LV Earthing at Ground Mounted Substations with Separate Items of Plant



5.5.2 Pole Mounted Substations

In most cases the criteria for combining HV and LV earthing cannot be satisfied at pole mounted substations. For the few cases where the criteria are met, the requirements are described below and shown in Figure 19:

- LV neutral is bonded to HV earth stud on transformer tank.
- All pole metalwork is bonded to the combined HV/LV earth.
- The earth electrode design is selected from the standard arrangements A, B, C or D (see Table 3).
- The earth electrode design shall include the additional requirements of Figure 6 or Figure 7 in order to provide adequate lightning protection.

Figure 19: Combined HV and LV Earthing at Pole Mounted Substations

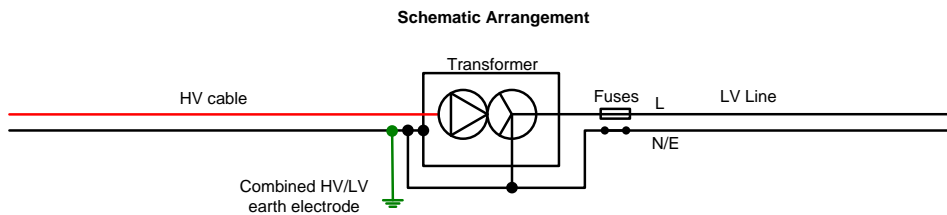
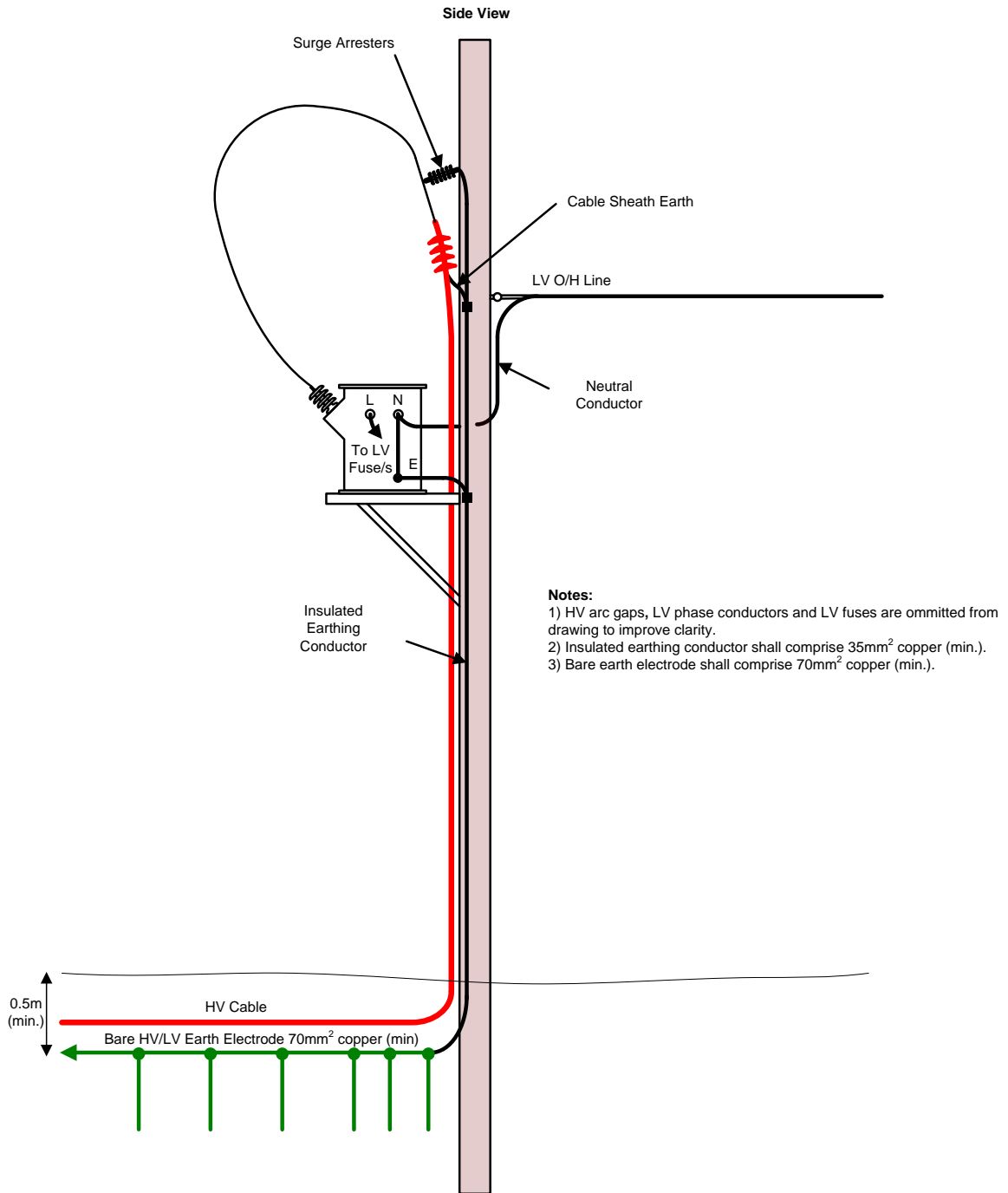

5.6 Distribution Substations - Segregated HV and LV Earthing

Where the criteria for combining HV and LV earthing systems cannot be met HV and LV electrodes shall be physically segregated. Buried HV electrode shall be segregated by at least 9m from buried LV electrode and from other buried metalwork or metallic services connected (directly or indirectly) to the LV earthing system.

HV earthing electrode shall be installed close to the associated HV equipment to provide adequate lightning protection and to minimise touch potentials in and around the HV equipment. LV electrode shall be segregated away from the HV electrode by using insulated earthing conductor (e.g. PVC insulated).

The insulated serving provided on modern cables such as consac, wavecon, tryden etc. ensure they are adequately segregated from HV electrode even when they are laid within 9m. The Hessian serving of older PILC (paper insulated, lead covered) LV cables does not have insulating properties and so where such cables are laid within 9m of an HV electrode they must be insulated by applying an appropriate wrap around the outside of the cable or by installing them within insulated and sealed ducting.

PME earth electrodes and bare LV earthing conductor installed as part of a standard underground service joint, must not be placed within 9m of an HV earth electrode.

The location of substations shall be chosen so that HV and LV electrodes can be adequately segregated. This will require substations to be placed well away from steel frame buildings, lightning protection electrodes, street lamps and other buried metallic services.

Following the installation of segregated HV and LV earthing systems a test shall, as far as is reasonably practicable, be carried out to confirm the two systems do not overlap. The test method is specified in ST: TP210.

Typical arrangements for segregating HV and LV earthing are shown in Figure 20 to Figure 30 inclusive.

The minimum LV and HV earthing electrode lengths that satisfy resistance and, where necessary, surface area requirements are chosen from Table 4. The minimum size of insulated earthing conductor (i.e. earthing conductor used above ground) is 35mm² (copper). The minimum size of bare earthing electrode is 70mm² (copper).

5.6.1 Ground Mounted and Pad Mounted Substations

The requirements for segregating HV and LV earths are described below and shown in Figure 20 and Figure 21:

- The HV earth electrode design is selected from the standard arrangements A, B, C or D (see Table 3).
- The LV earth electrode design is selected from the standard arrangements A, B or C (see Table 3).
- HV LV earth link (connecting between the HV earth bar and the LV neutral earth bar) shall be disconnected.
- Any LV sockets within the cabinet shall be removed.
- HV Cable sheaths shall be bonded directly to the HV earthing system (it is not acceptable to rely on a fortuitous connection through HV metalwork).
- Where an HV metering unit is installed this shall be bonded to the HV earthing system (it is not acceptable to rely on a fortuitous connection through HV metalwork).
- **The first section of HV electrode shall be buried immediately in front of the HV cabinet / HV switchgear to help reduce touch potentials (potential difference between hands and feet) for operators.**
- Insulated LV earth conductor shall be connected to the LV neutral (inside LV fuse cabinet) and laid away from the substation, in a separate trench to the HV electrode (preferably in the opposite direction from the HV earth electrode). The LV earthing conductor shall be connected to bare earthing electrode once the 9m segregation distance is achieved.
- Where necessary a separate substation earth bar may be installed to enable multiple earth connections to be made.
- LV substation auxiliary supplies (e.g. for lighting, sockets etc.) are not normally provided where HV and LV earths are segregated. If auxiliary supplies are required the following guidance shall be followed:
 - (i) If only substation lighting is required all the associated equipment (light fittings, switches etc.) shall comprise entirely of Class II equipment, as defined in to BS 7671 (i.e. double insulated equipment that does not have an earth connection). The circuit shall be derived from the LV busbars and shall be suitably fused. Live and neutral conductors (only) shall be run within plastic conduit to the switches and light fittings. An earth conductor (circuit protective conductor) shall not be installed.
 - (ii) If auxiliary supplies are required for sockets or other equipment that requires an earth (e.g. battery charger, actuators etc.) these supplies shall be derived from a 1:1 isolation transformer rated for 7kV a.c. for 1 minute between windings and between the incoming winding and the casing shall be installed. Further information is given in Figure 22.
- Metal HV metering panels shall be bonded to the substation HV earth. A minimum distance of at least 2m shall be maintained between any extraneous metalwork associated with the HV metering panel and extraneous metalwork connected to the LV earth, to prevent hazardous touch potentials (see Figure 23).
- Pad mounted transformers must be installed within GRP enclosures or fenced off (preferably with non-conducting fencing materials, such as wood) to minimise the touch potential risk.
- Guidance on substation fencing is provided in 5.7.

Figure 20: Segregated HV and LV Earthing at Unit Type Ground Mounted & Pad Mounted Distribution Substations

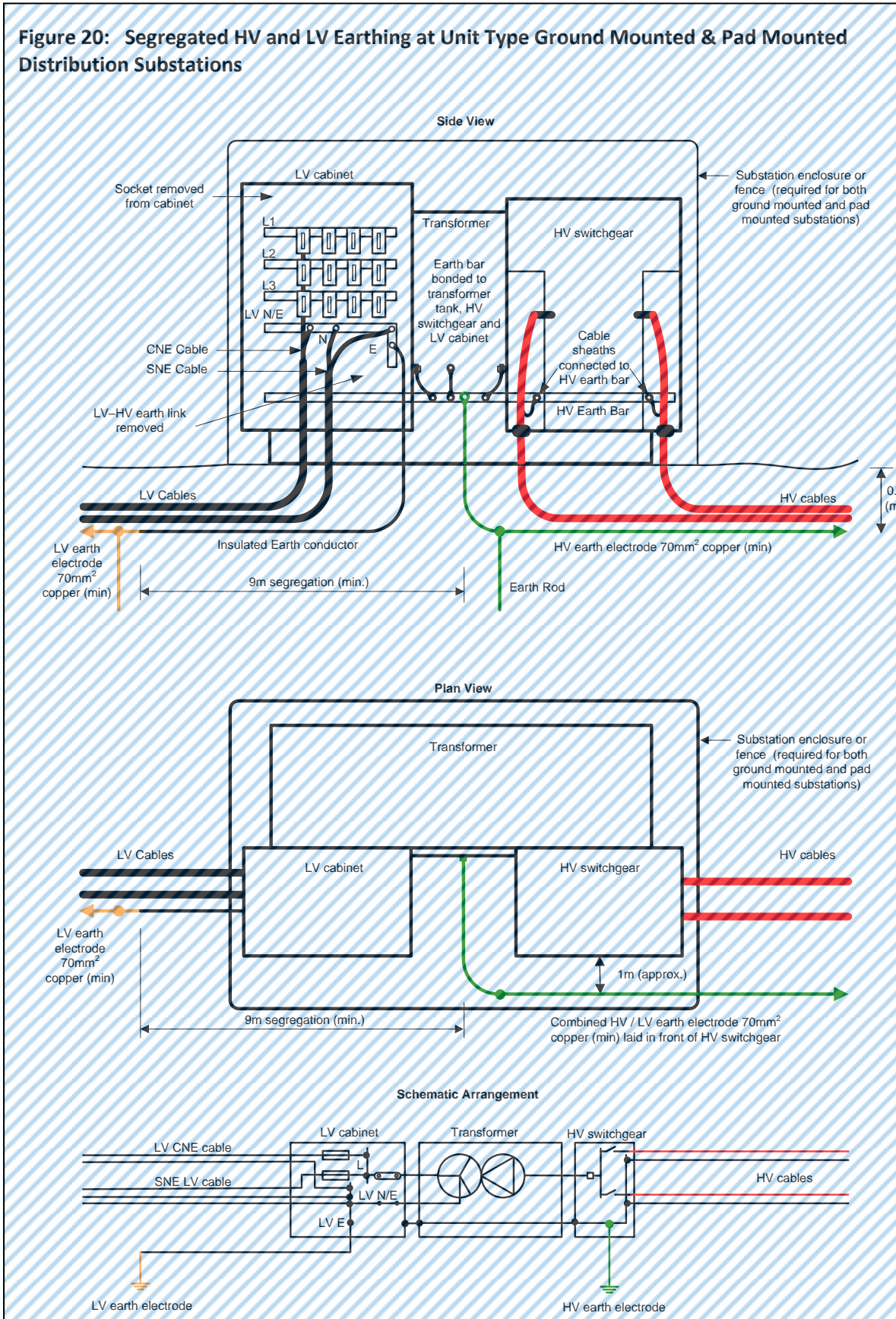

Figure 21: Segregated HV and LV Earthing at Ground Mounted Substations with Separate Items of Plant

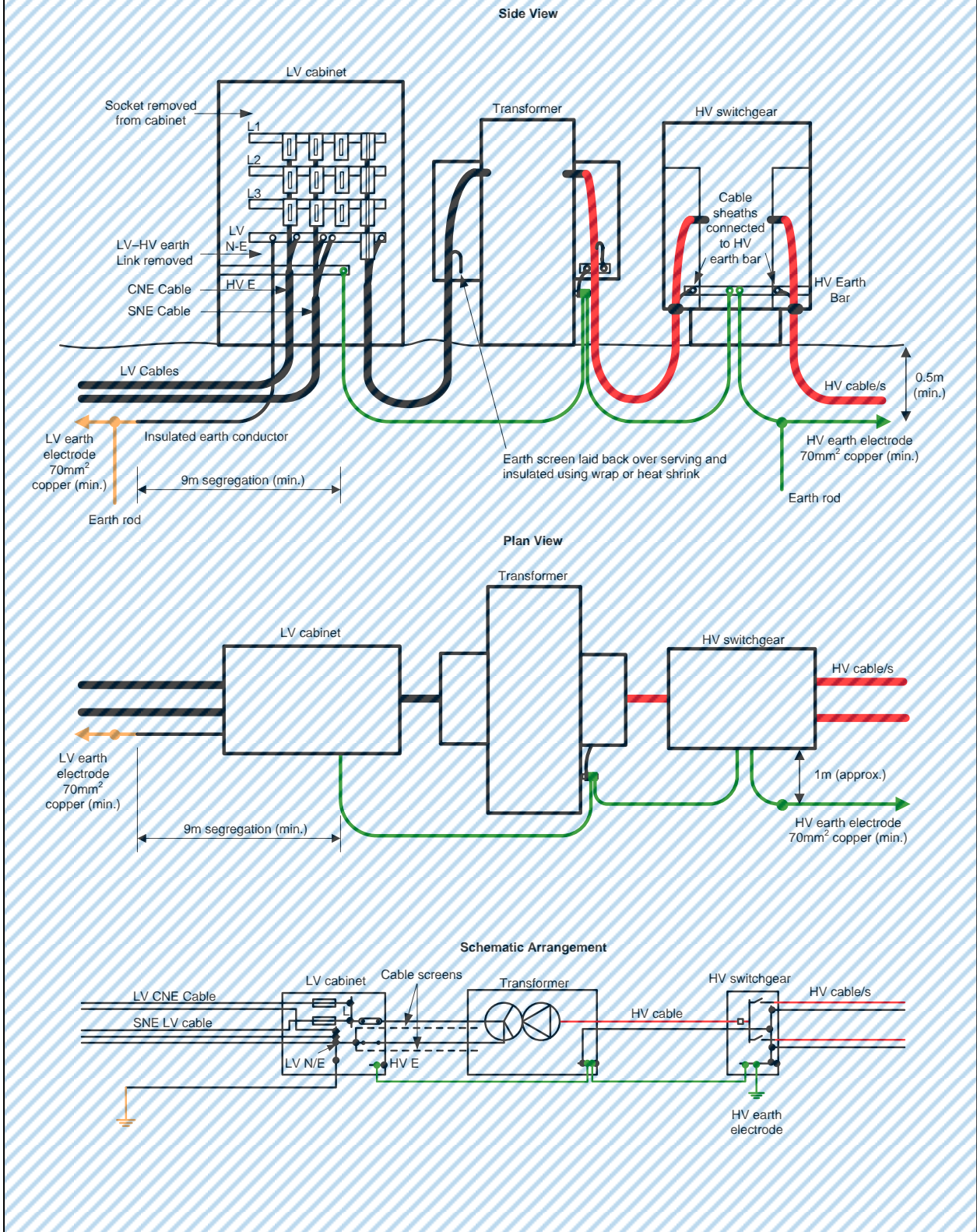

Figure 22: Provision of Substation Auxiliary Supplies where HV and LV Earths are Segregated

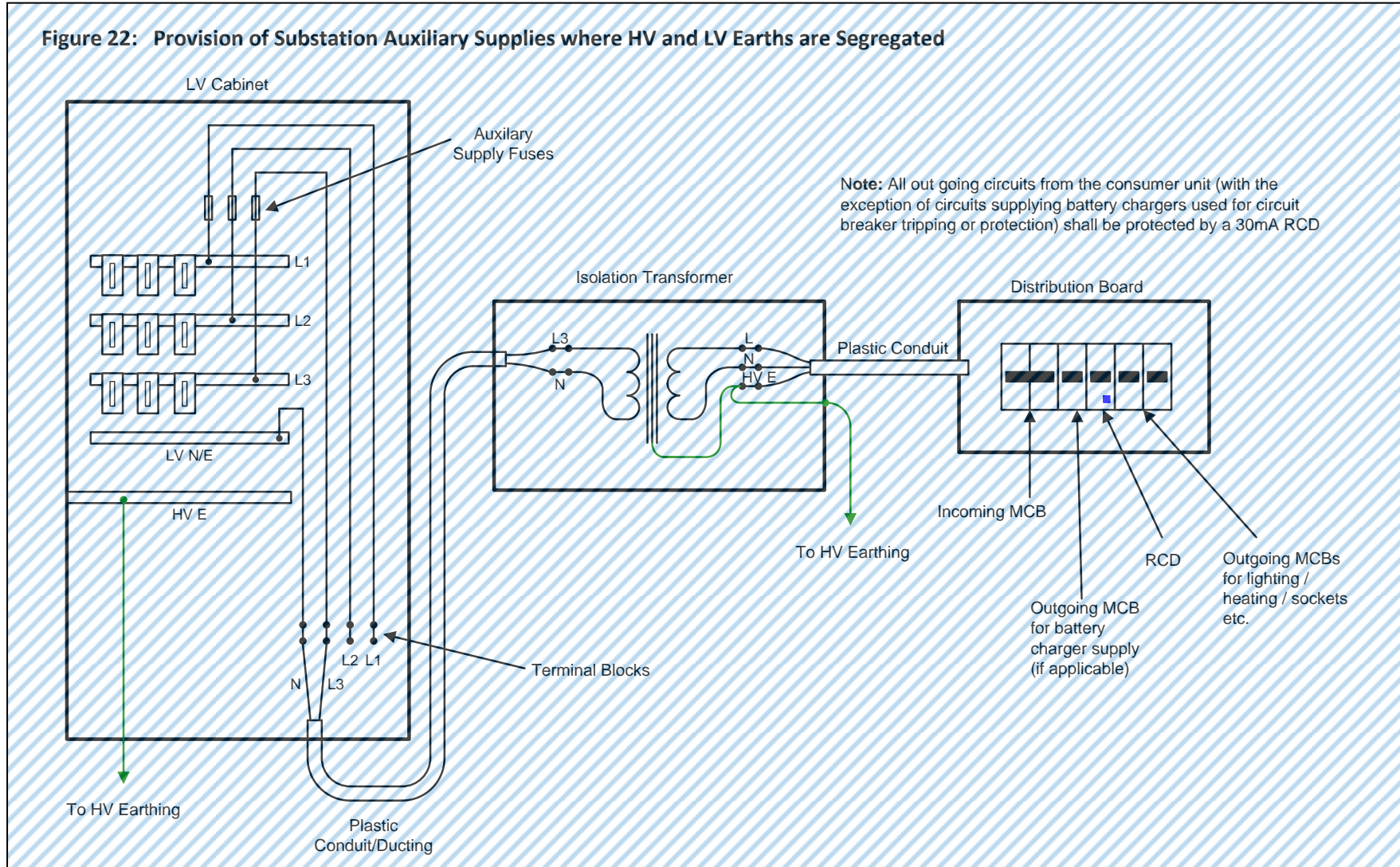
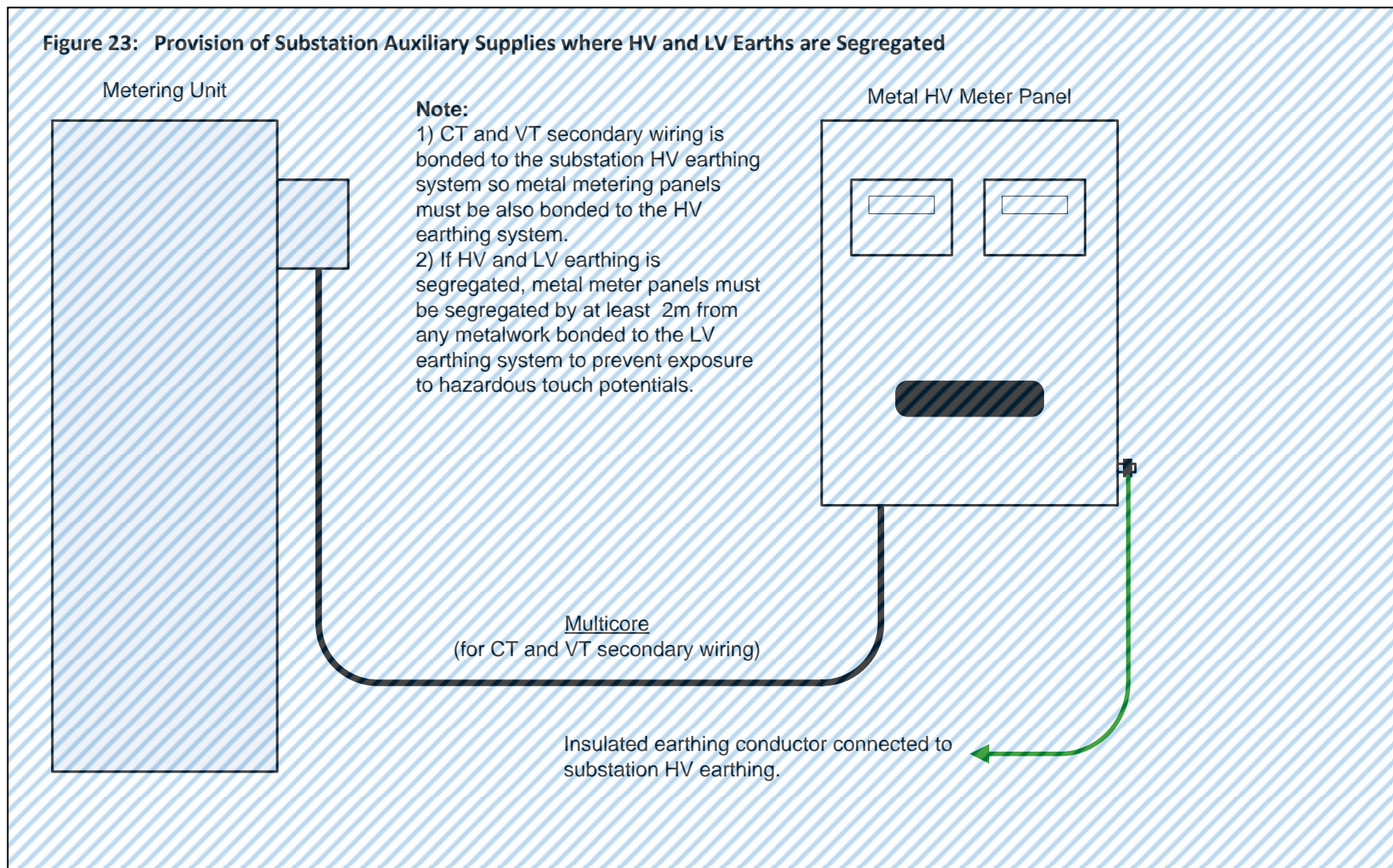

Figure 23: Provision of Substation Auxiliary Supplies where HV and LV Earths are Segregated



5.6.2 Pole Mounted Substations

Figure 24 to Figure 30 inclusive show a number of methods for segregating HV and LV earthing at pole mounted substations. In each case the following requirements also apply:

- HV earth electrode design is selected from the standard arrangements A, B, C or D (see Table 3) and the additional requirements of Figure 6 or Figure 7 incorporated in order to provide adequate lightning protection.
- The LV earth electrode design is selected from the standard arrangements A, B or C (see Table 3).
- A neutral-earth surge arrester is installed between the substation LV neutral and metalwork earth.
- HV earth conductor shall be placed as far as possible from LV earth, neutral and phase conductors (i.e. on opposite sides of the pole) to prevent, as far as possible lightning causing a flashover between the two earthing systems.
- Where hessian served LV cables (e.g. PILC cables) are installed within 9m of HV earthing electrode they shall be insulated by applying a suitable wrap or by installing them within insulating (e.g. polyethylene) ducts which are then sealed to prevent moisture ingress. Any hessian served HV cables laid within 9m of the bare LV electrode must be insulated using the same technique.
- The LV earth electrode shall be connected to LV neutral using one of the following options:
 - Option 1 LV neutral is earthed at the transformer pole (see Figure 24, Figure 25, Figure 26 and Figure 27)
 - Option 2 LV neutral is earthed one span away from the transformer pole (see Figure 28). This method is only acceptable where only one LV circuit is connected to the transformer and this circuit runs away from the transformer pole in just one direction. In addition, all customer connections must be provided at or beyond the pole connected to the main LV earth electrode. These restrictions minimise the risk of customer connections becoming disconnected from earth if the overhead line is damaged or if work being carried out on the overhead line.
 - Option 3 LV neutral is earthed at the customer connection point (see Figure 29 and Figure 30). These options utilise PNB (protective neutral bonding) earthing and may only be used where the substation provides just one connection point. PNB must not be offered where more than one connection point is to be provided from the substation.

Figure 24: Segregating HV and LV Earthing at Pole Mounted Substations - LV earth connected at transformer pole - HV and LV overhead lines

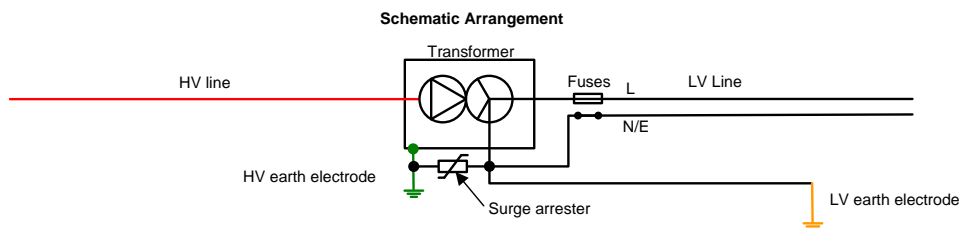
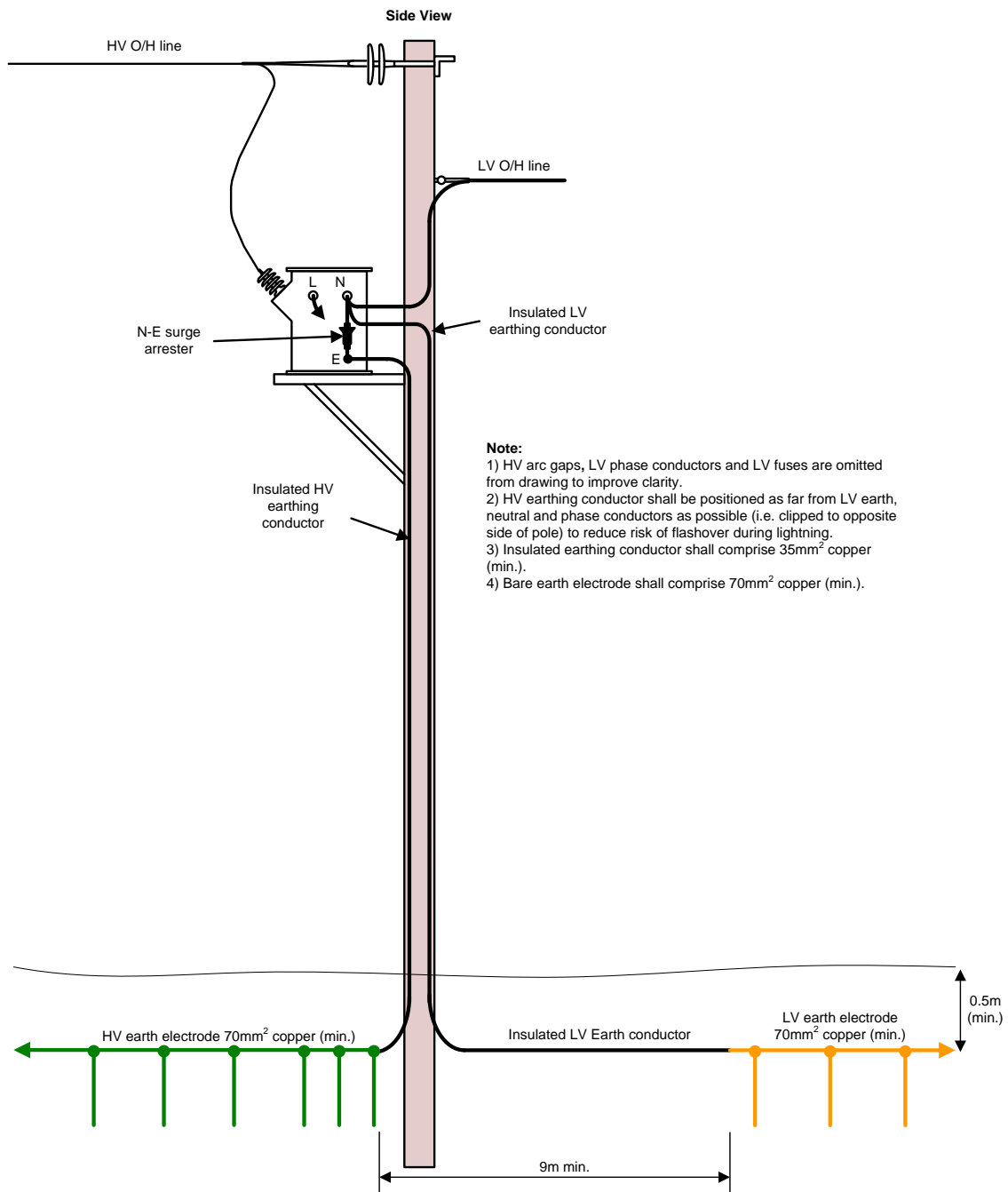

Figure 25: Segregating HV and LV Earthing at Pole Mounted Substations - LV Earth Connected at Transformer Pole - HV Overhead Line, LV Cable

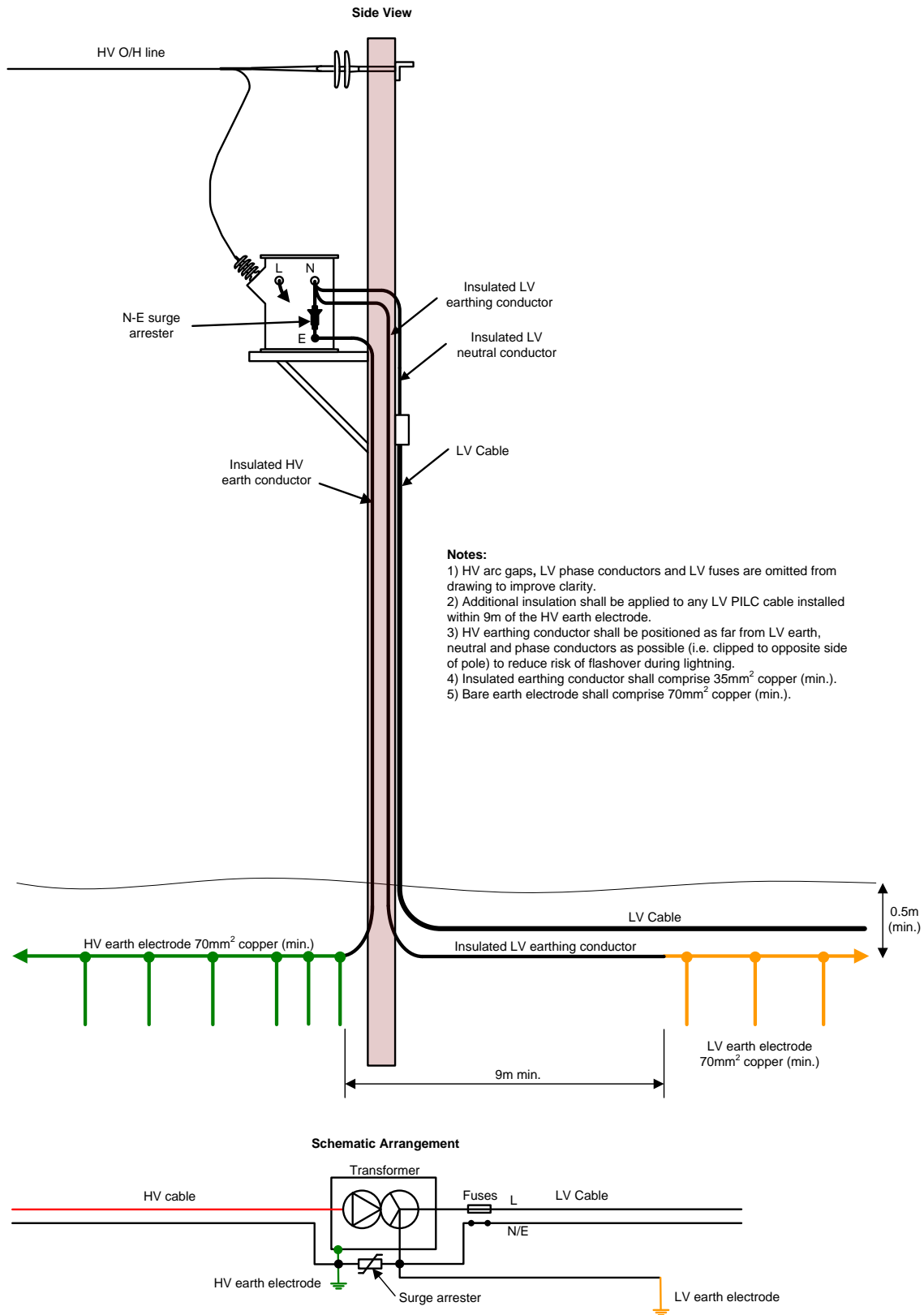

Figure 26: Segregated HV and LV Earthing at Pole Mounted Substations - LV Earth Connected at Transformer Pole - HV Cable, LV Overhead Line

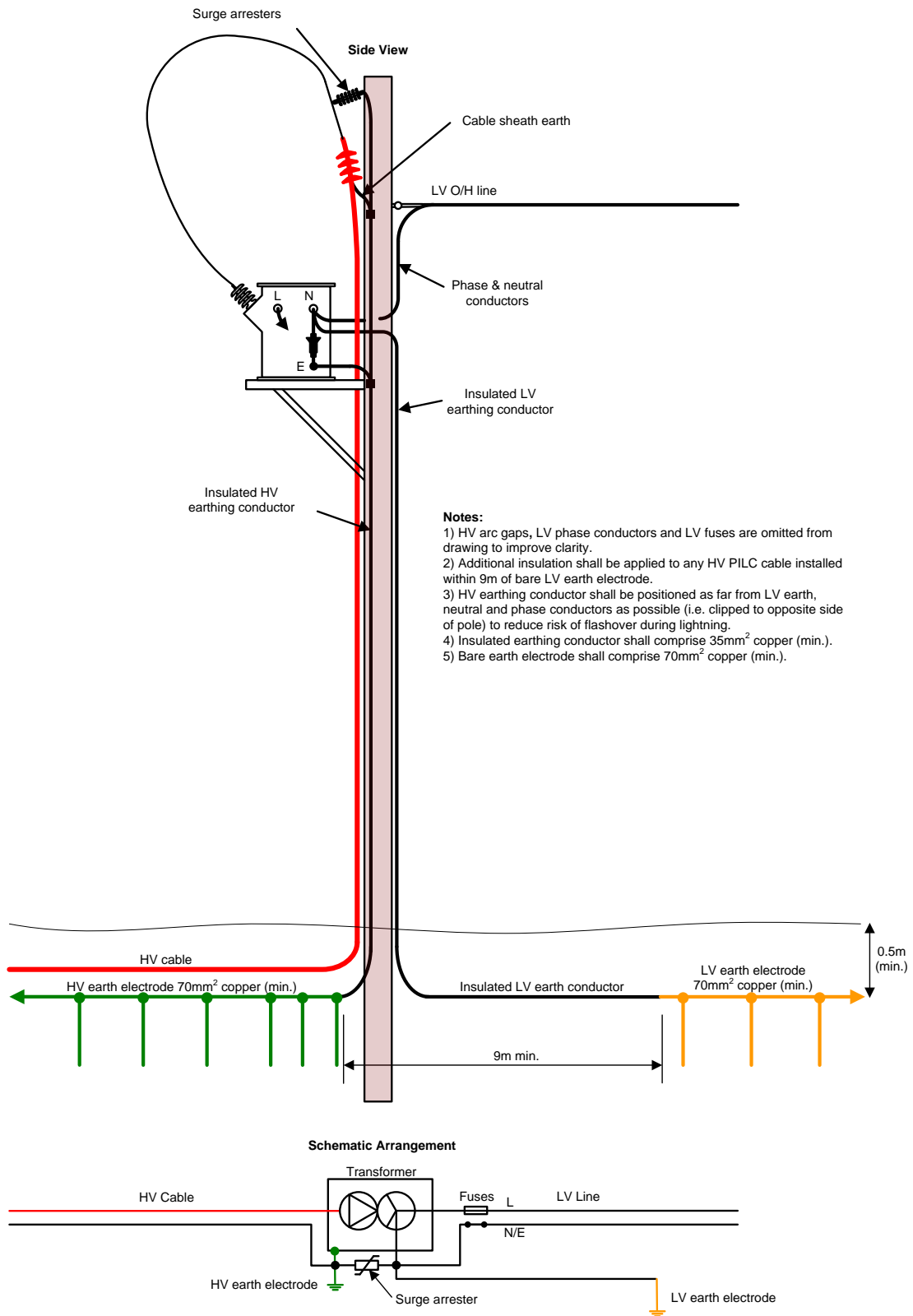

Figure 27: Segregated HV and LV Earthing at Pole Mounted Substations - LV Earth Connected at Transformer Pole - HV and LV Cable

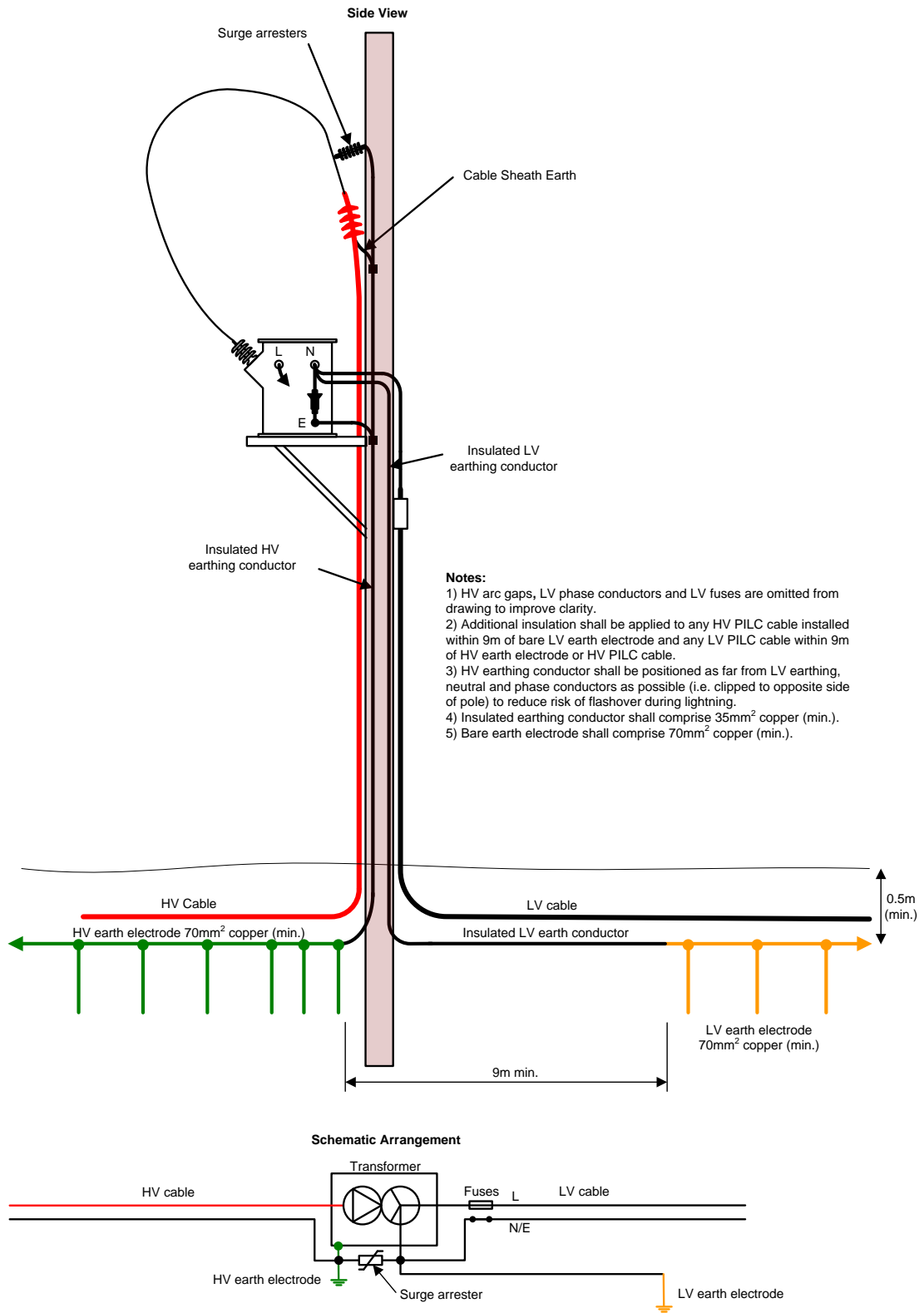

Figure 28: Segregated HV and LV Earthing at Pole Mounted Substations - LV Earth Connected One Span from the Transformer Pole

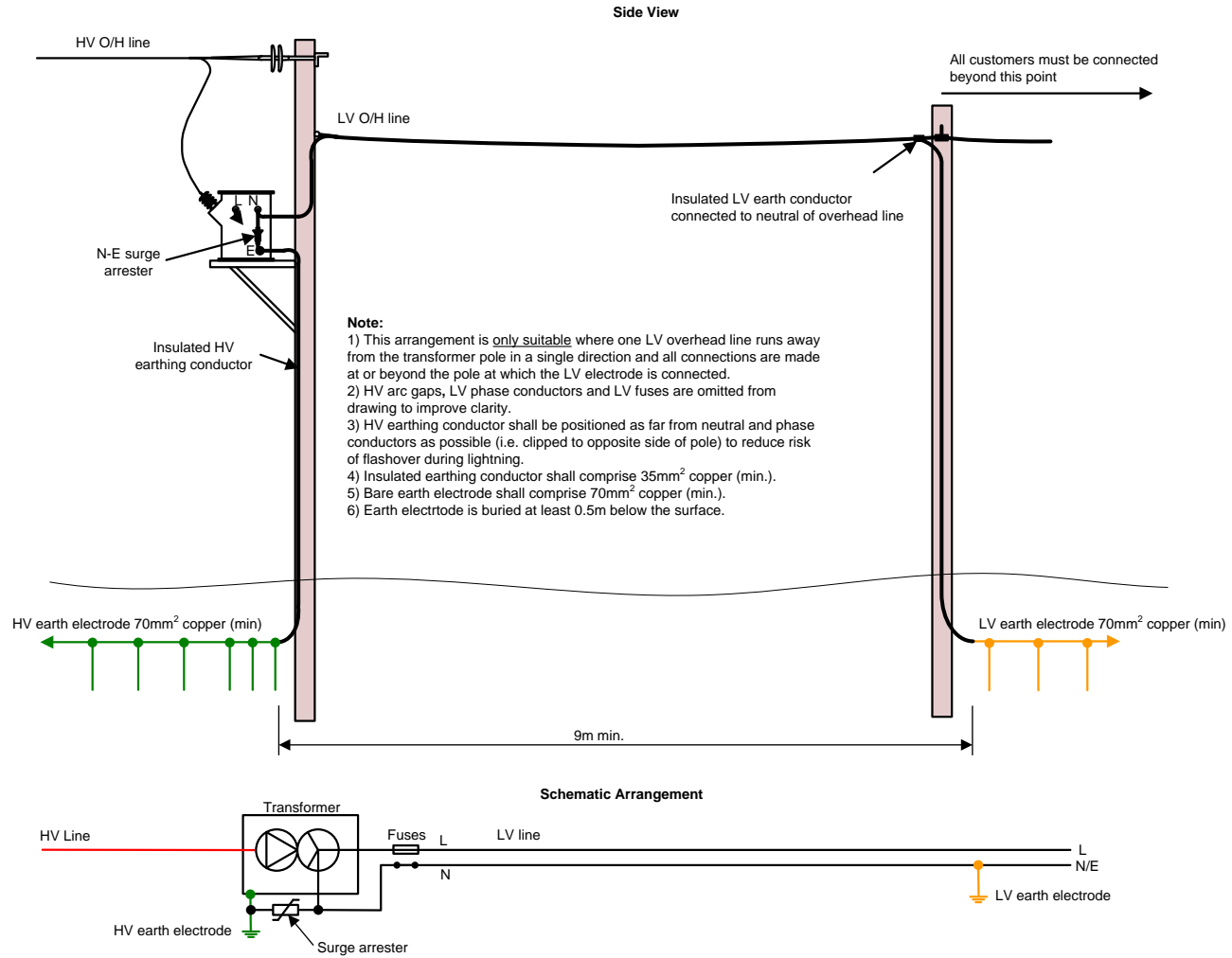

Figure 29: Segregated HV and LV Earthing at Pole Mounted Substations - PNB (TN-C-S) with LV Earth Connected to Neutral Outside Customer's Property

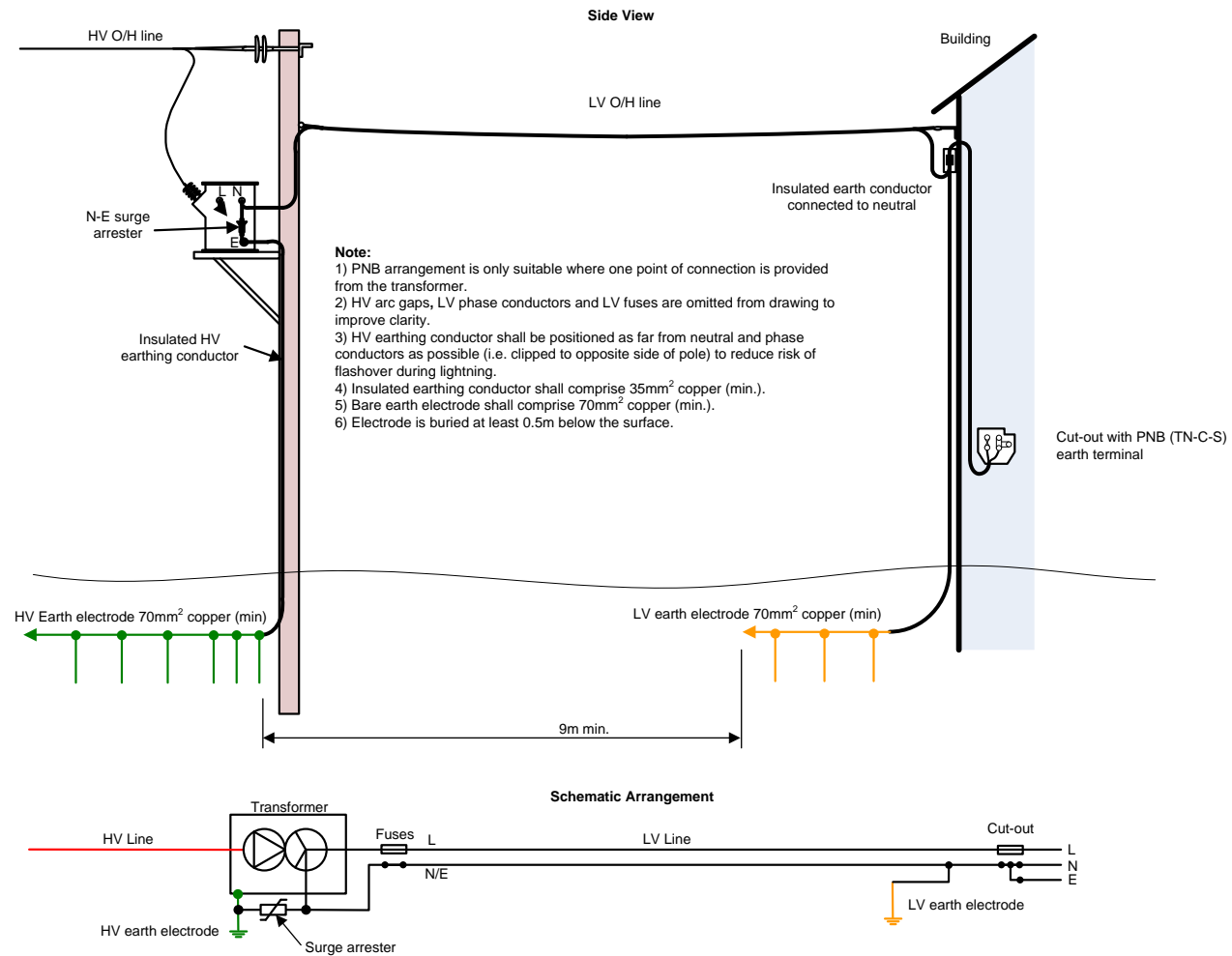
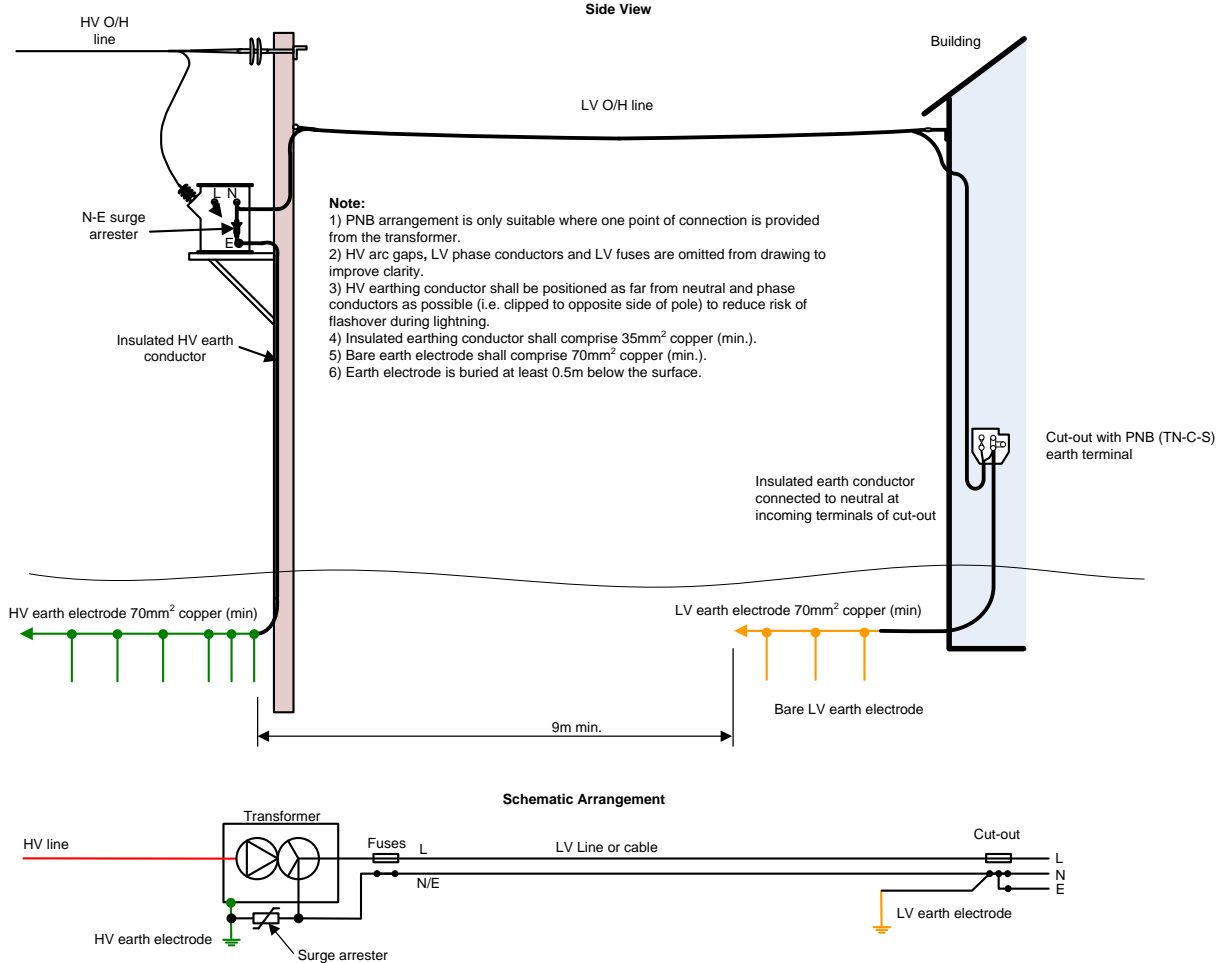

Figure 30: Segregating HV and LV Earthing at Pole Mounted Substations - PNB (TN-C-S) with LV earth connected to neutral at cut-out



5.7 Distribution Substations - Enclosures, Doors and Fencing

Distribution substation enclosures, doors and fences should be constructed from non-conducting materials whenever possible, to eliminate any risk from hazardous potentials. In some cases it is necessary to install metal doors, enclosures or fencing for security reasons. Earthing requirements for enclosures, metal fences and metal doors are described below:

a) Fibreglass Enclosures

Fibreglass substations enclosures are commonly installed around distribution substations to provide a reasonable level of security and environmental protection. Fibreglass is a good insulator and eliminates touch potential hazards between the enclosure itself and the substation plant. The metal strip that is fitted below the door (known as a threshold strip) shall be bonded to the HV earth of the substation using copper conductor with a minimum cross-sectional area of 50mm².

b) Steel anti-vandal enclosures with resin and grit coating

Metal anti-vandal substation enclosures are available that are coated with a layer of fibre glass resin impregnated with fine gravel or grit. The enclosure itself must be bonded to the substation HV earthing system using copper conductor with a minimum cross-section of 50mm², to prevent hazardous touch potentials (between the substation plant and the metallic enclosure) using copper conductor. The external coating is highly insulating and therefore hazardous touch potentials outside the substation are eliminated (assuming the outer coating is intact). If the outer coating is damaged and significant areas of steel are exposed the enclosure should be replaced.

c) Steel enclosures with painted finish

In the past painted steel enclosures were often installed around distribution substations. These steel enclosures must be bonded to the substation HV earthing system with a copper conductor with a minimum cross-sectional area of 50mm² to prevent hazardous touch potentials between the enclosure and the substation plant.

i) Combined Substation Earthing

Where the substation's HV and LV earths are combined (i.e. the site is defined as cold) no further precautions are required for steel enclosures

ii) Segregated Substation Earthing

If the HV and LV earthing systems are segregated (i.e. the site is "hot") the steel enclosure should be surrounded by non-metallic fencing that prevents members of the public touching the enclosure.

If a non metallic fence is not suitable (due to the risk of vandalism) then a metal fence may be installed instead, but this fence must be segregated by at least 2m from the steel enclosure (and any other substation metalwork). This metal fence shall be earthed independently from the substation. See option d) for further details.

d) Metal fencing

i) Combined Substation Earthing

Where the associated distribution substation has combined HV and LV earthing (i.e. the site is defined as “cold”) the fencing shall be bonded to the substation earthing system. Gates must be bonded together (using a length of earth electrode buried in the ground beneath the gate). Gates and gateposts shall be bonded together using a flexible copper conductor. Further details are shown in Figure 31 and Figure 32.

ii) Segregated Substation Earthing

Metal Fencing should be avoided at Substations with segregated HV and LV earthing (e.g. hot sites) whenever possible in order to minimise the risk from hazardous potentials.

Where there is no alternative to installing metal fencing, the only practical option is to separate the fence by at least 2m from all substation metalwork and earth it independently from the substation’s HV and LV earthing system. Substation earth electrode installed within 2m of the substation fencing must be insulated (e.g. by placing it within insulating ducting). Gates must also be bonded together (using a length of earth electrode buried in the ground beneath the gate). Gates and gateposts shall be bonded together using a flexible copper conductor. Further details are given in Figure 33 and Figure 34.

e) Metal Doors

Requirements for metal doors are identical to the requirements for metal gates, described in d) above.

Figure 31: Independently Earthed Metal Fencing at Substations with Combined HV/LV Earthing

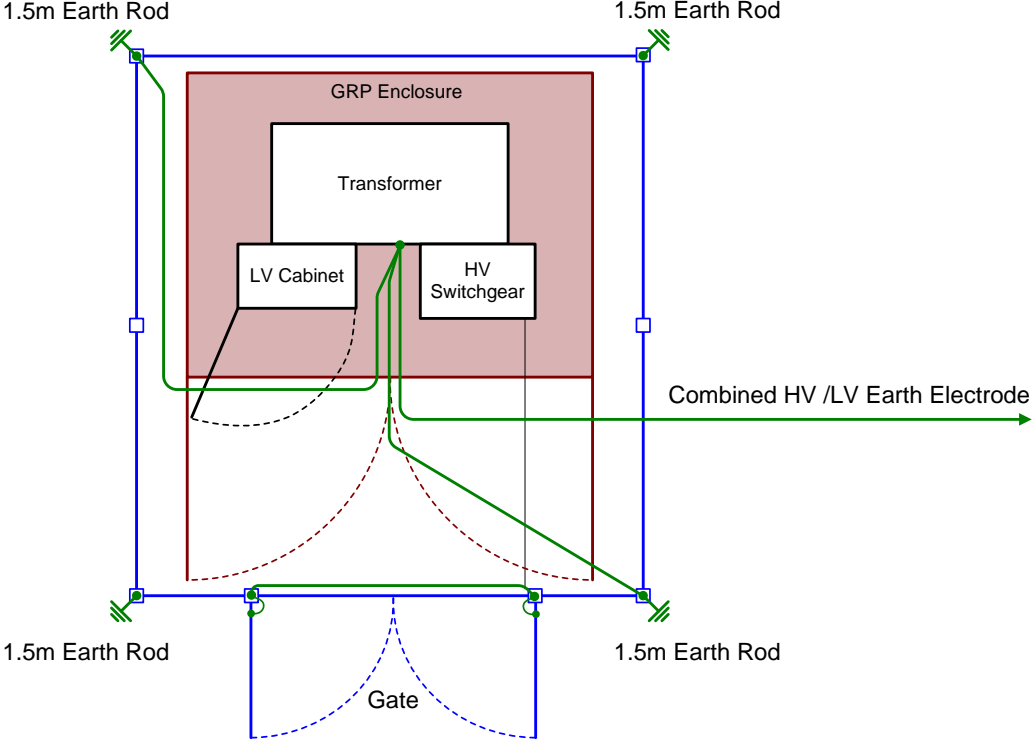

Note:

- 1) Fence is bonded to substation earth electrode
- 2) 1.5m earth rods are installed at each corner and bonded to metal corner posts or metal fence panels.
- 3) Bare copper earth conductor is buried beneath each gateway and bonded to the gate posts and gates.
- 4) Each metal fence panel shall be electrically connected to the adjacent fence post and adjacent panel either by virtue of the metal fixings or by applying additional earth bonds.
- 5) Copper conductor used to bond the fencing shall have minimum cross-sectional area of 50mm². Flexible copper bonds between gateposts and gates shall have a minimum cross-sectional area of 35mm². Substation earth electrode shall have a minimum cross-sectional area of 70mm².

Figure 32: Metal Fencing Bonded to the Substation Earthing System at Substations with Combined HV/LV Earthing

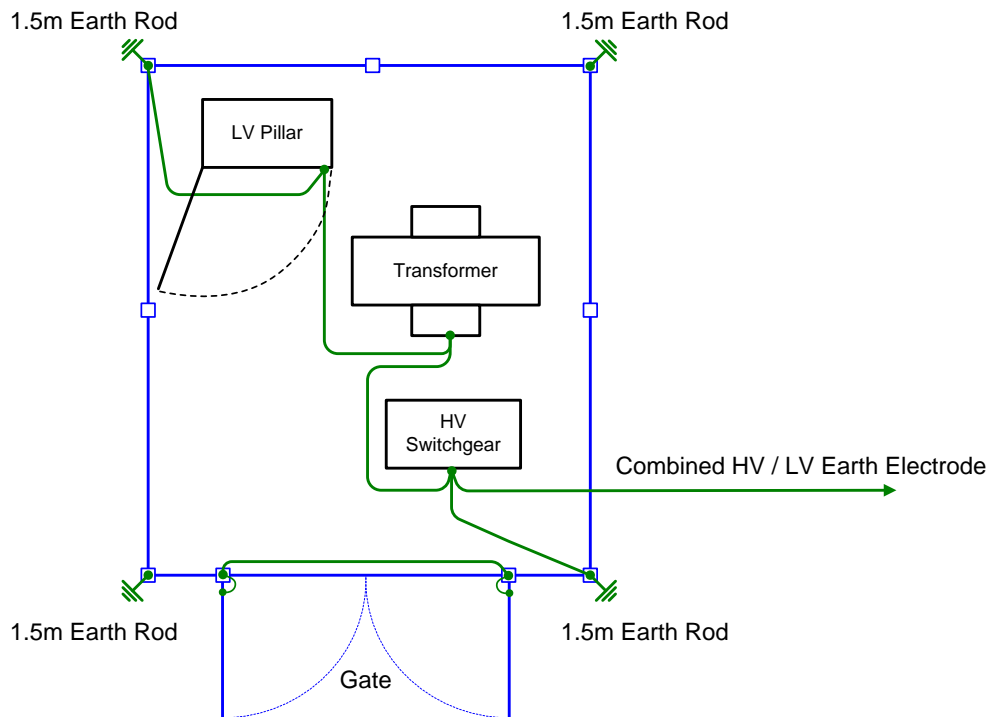

Note:

- 1) The fencing is bonded to the substation earthing at 2 points (or more). Ideally these connections should be on opposite sides/corners of the substation.
- 2) 1.5m earth rods are installed at each corner and bonded to metal corner posts or metal fence panels.
- 3) Bare copper earth conductor is buried beneath each gateway and bonded to the gate posts and gates.
- 4) Each metal fence panel shall be electrically connected to the adjacent fence post and adjacent panel either by virtue of the metal fixings or, where necessary by applying additional earth bonds.
- 5) Copper conductor used to bond the fencing and shall have minimum cross-sectional area of 50mm². Flexible copper bonds between gateposts and gates shall have a minimum cross-sectional area of 35mm². Substation earth electrode shall have a minimum cross-sectional area of 70mm².

Figure 33: Independently Earthed Metal Fencing System at Substations with Segregated HV and LV Earthing (Outdoor Arrangement)

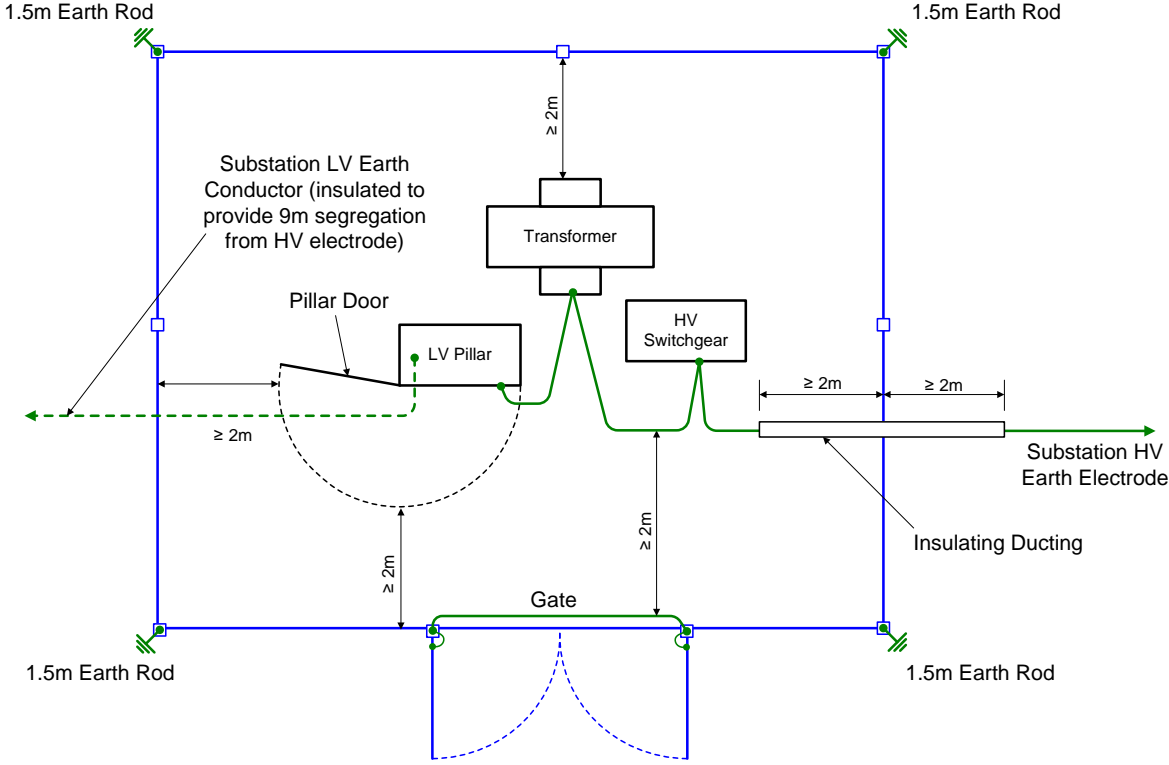

Note:

- 1) Fencing must be segregated from substation metalwork by at least 2m.
- 2) HV and LV earth electrodes are segregated by 9m.
- 3) Bare HV electrode is laid 1m in front of HV switchgear.
- 4) HV electrode is insulated where it passes within 2m of the metallic fence (e.g. by laying it inside plastic ducting).
- 5) 1.5m earth rods are installed at, and bonded to, each corner post or fence panel.
- 6) Each metal fence panel shall be electrically connected to the adjacent fence post and adjacent panel either by virtue of the metal fixings or, where necessary by applying additional earth bonds.
- 7) Bare copper earth conductor is buried beneath each gateway and bonded to the gate posts and gates.
- 8) Copper conductor used to bond the fencing shall have minimum cross-sectional area of 50mm². Flexible copper bonds between gateposts and gates shall have a minimum cross-sectional area of 35mm². Substation earth electrode shall have a minimum cross-sectional area of 70mm².

Figure 34: Independently Earthed Metal Fencing System at Substations with Segregated HV and LV Earthing (GRP Enclosure)

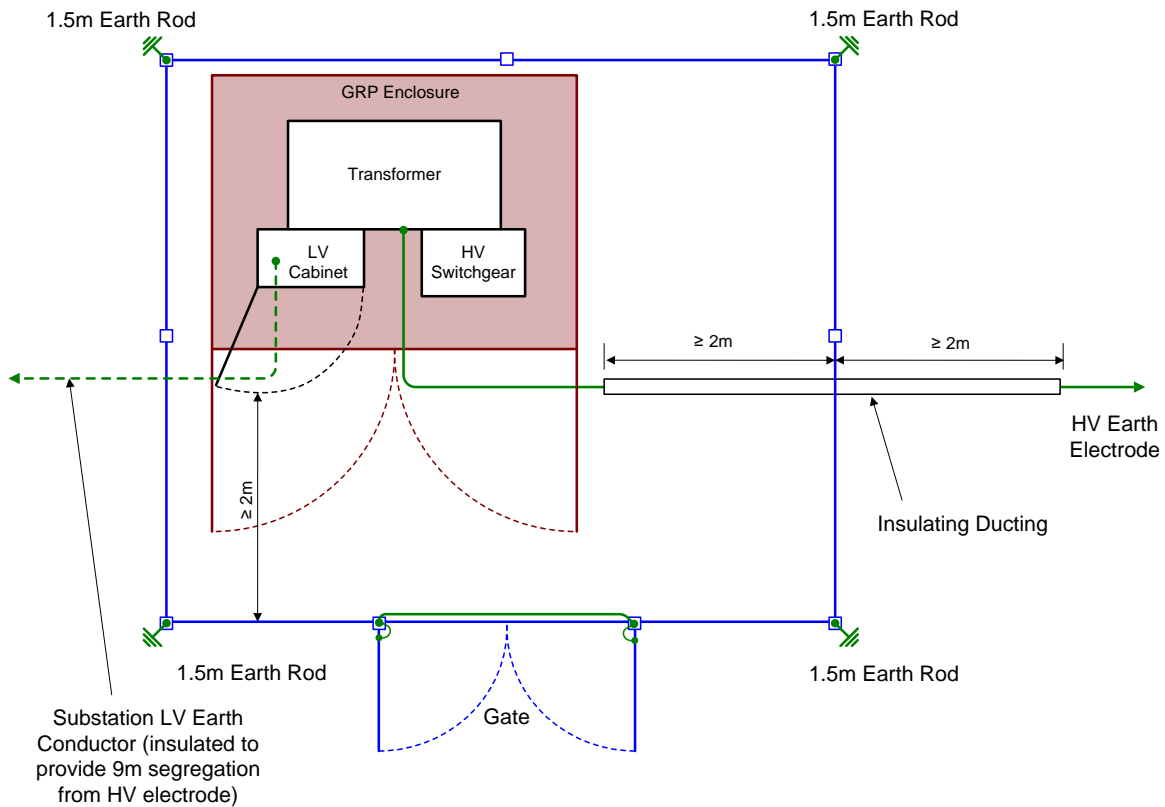

Note:

- 1) Fencing must be segregated from substation metalwork by at least 2m.
- 2) HV and LV earth electrodes are segregated by 9m.
- 3) Bare HV electrode is laid 1m in front of HV switchgear.
- 4) HV electrode is insulated where it passes within 2m of the metallic fence (e.g. by laying it inside plastic ducting).
- 5) 1.5m earth rods are installed at, and bonded to, each corner post or fence panel.
- 6) Each metal fence panel shall be electrically connected to the adjacent fence post and adjacent panel either by virtue of the metal fixings or, where necessary by applying additional earth bonds.
- 7) Bare copper earth conductor is buried beneath each gateway and bonded to the gate posts and gates.
- 8) Copper conductor used to bond the fencing shall have minimum cross-sectional area of 50mm^2 . Flexible copper bonds between gateposts and gates shall have a minimum cross-sectional area of 35mm^2 . Substation earth electrode shall have a minimum cross-sectional area of 70mm^2 .

5.8 Distribution Substations - Pole Mounted Equipment (Excluding Transformers)

Most 11kV and 6.6kV overhead lines owned by WPD utilise unearthed construction (i.e. an earth wire is not provided and at the majority of poles the steelwork is left un-earthed).

Where equipment is installed on the poles, e.g. switchgear the associated metalwork, including pole steelwork and brackets often has to be earthed. A list of pole-mounted equipment that requires earthing is given in 5.2. Pole metalwork is also earthed on poles that are jointly used by WPD and British Telecom.

Earth electrode designs shall be in accordance with Section 4 of this document. The HV earth electrode design shall be selected from the standard arrangements A, B, C or D (see Table 3). Earthing conductor clipped to the pole shall be suitably insulated to prevent hazardous touch potentials.

Where surge arresters or triggered arc gaps are installed the earth electrode shall include the additional requirements of Figure 6 or Figure 7 in order to provide adequate lightning protection. The earthing conductor shall be kept as short and straight as possible in order to minimise the earthing system impedance for lightning impulses.

Specific requirements for earthing air break switch disconnectors (ABSDs) with handles operated from ground level and for pole-mounted equipment with control cubicles accessible without a ladder, are specified below:

5.8.1 ABSDs with Handle Operated from Ground Level

New and substantially modified ABSDs shall be installed with a surface laid operator earth mat which is connected to the operating handle (see Figure 35). Equipment installed prior to the issue of this document have been provided with a buried operator earth mat instead (see Figure 36).

The earth mat shall be placed directly in front of the operating handle and bonded to the handle so that the operator stands on the earth mat (if surface laid) or directly above the mat (if buried) when operating the ABSD.

The operating rod shall include a suitable insulating insert to prevent hazardous potentials being transferred to the handle.

Pole top metalwork shall be connected to a buried earth electrode which is segregated by at least 9m from the operator earth mat.

The HV metalwork earth conductor shall be clipped to the opposite side of the pole to the operating handle earth conductor to minimise the chance of a flashover between the two earthing systems.

5.8.2 Switchgear and Regulators with Ground Level Control Boxes

Requirements for pole-mounted switchgear and regulators with control cubicles accessible without a ladder are shown in Figure 37 and are similar to requirements for ABSDs described above. The main difference is that the control cubicle is bonded to the switchgear by virtue of their umbilical cable and therefore it is not possible to segregate the control cubicle (and operating mat) earthing from the switchgear earthing.

Pole top metalwork and control cubicle metalwork is connected to the earth mat and to a buried earth electrode.

The earth mat shall be placed directly in front of the operating handle in a position that ensures the operator will stand on the earth mat when operating the equipment. This arrangement keeps touch potentials to a minimum should an earth fault occur on the pole.

Retrospective action is required to install a surface laid earth mat at any existing site that does not already have one. MOD 378 has been set up in CROWN to schedule / monitor this work. Where an existing earth mat is in place, but it is smaller than the minimum size specified in Figure 37, it is not necessary to replace it with a larger one.

Figure 35: Arrangement for all New ABSDs that have an Operating Handle at Ground Level

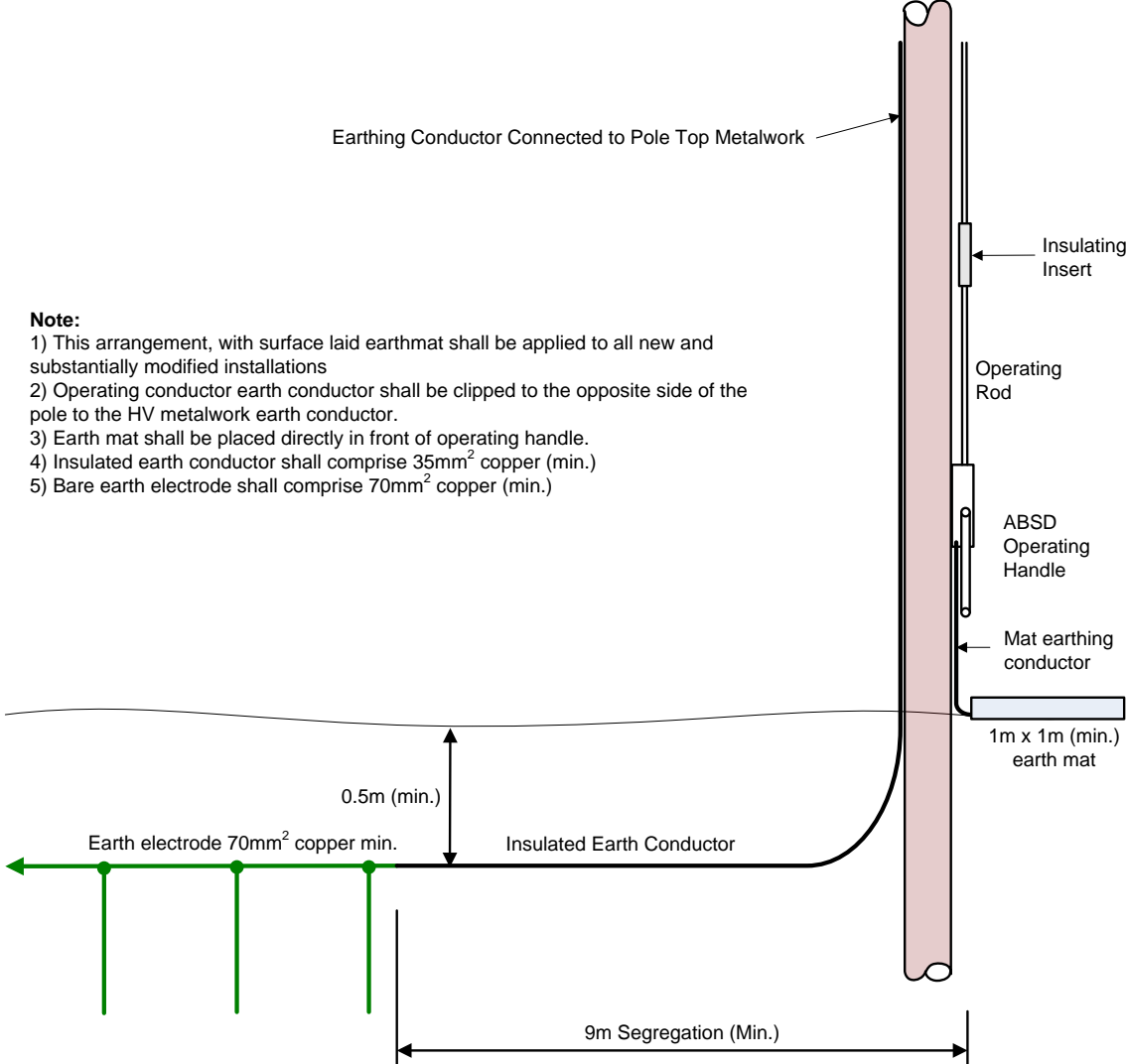

- Note:**
- 1) This arrangement, with surface laid earthmat shall be applied to all new and substantially modified installations
 - 2) Operating conductor earth conductor shall be clipped to the opposite side of the pole to the HV metalwork earth conductor.
 - 3) Earth mat shall be placed directly in front of operating handle.
 - 4) Insulated earth conductor shall comprise 35mm² copper (min.)
 - 5) Bare earth electrode shall comprise 70mm² copper (min.)

Figure 36: Historical Arrangement for Existing ABSDs with Operating Handles at Ground Level

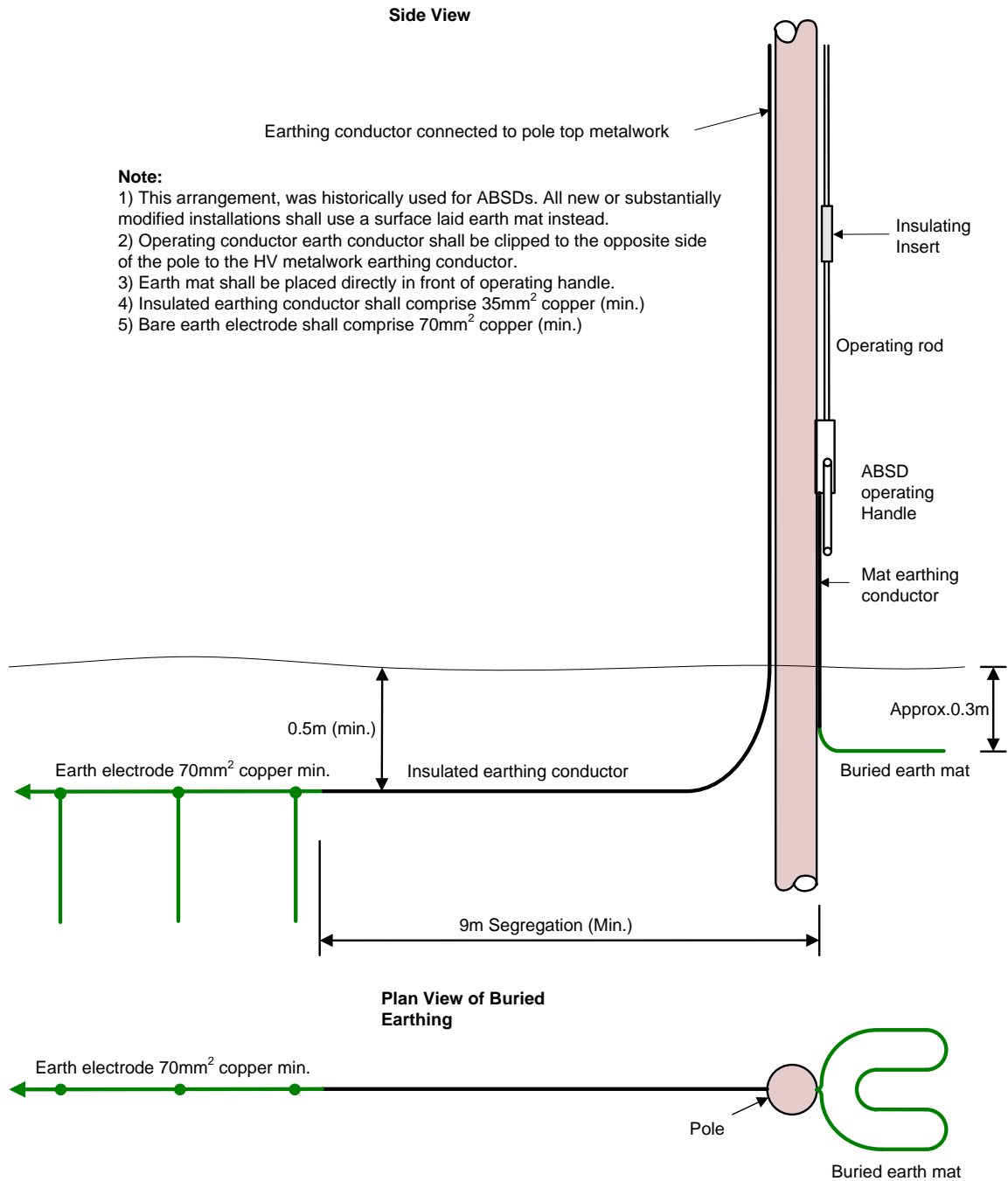
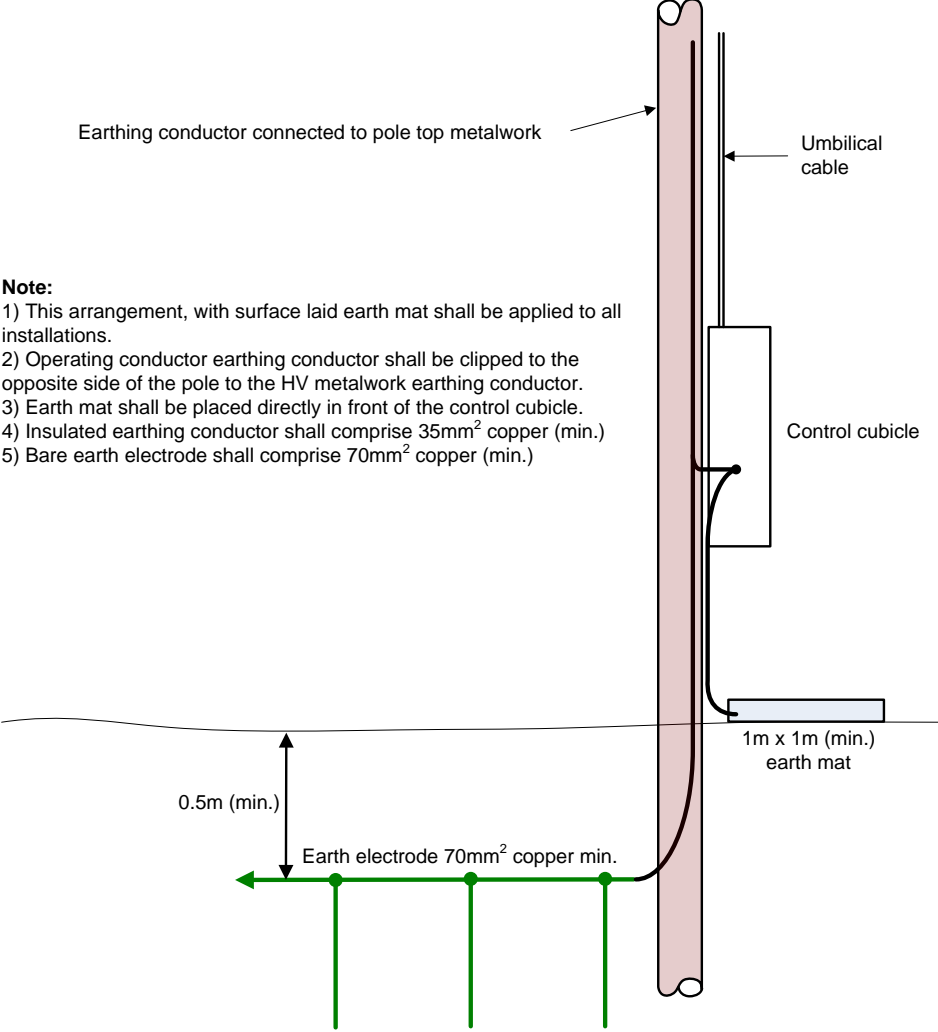

Figure 37: HV Pole Mounted Equipment with a Control Cubicle Accessible at Ground Level



- Note:**
- 1) This arrangement, with surface laid earth mat shall be applied to all installations.
 - 2) Operating conductor earthing conductor shall be clipped to the opposite side of the pole to the HV metalwork earthing conductor.
 - 3) Earth mat shall be placed directly in front of the control cubicle.
 - 4) Insulated earthing conductor shall comprise 35mm² copper (min.)
 - 5) Bare earth electrode shall comprise 70mm² copper (min.)

5.9 HV Cables

All HV cables have a continuous metallic screen and this screen must be maintained through all joints and terminations. The screen shall be connected to earth at both ends of the cable in accordance with POL: CA6, unless otherwise agreed by the Policy Section.

When cables are terminated within switchgear, a bond must be connected between the cable screen and the switchgear HV earth bar, taking into account any special requirements for frame leakage busbar protection, CTs (e.g. core balance CTs), and earth fault passage indicators. It is not acceptable to just rely on the fortuitous connection between the cable gland and switchgear metalwork. Further guidance is provided in the ST: CA2 series of company directives, and also in ST: CA6B and ST: SP1FC.

Traditional paper insulated, lead covered (PILC) cables have a hessian serving which, after installation, provides a good electrical contact between the cable armouring and screen to earth. Where such cables are widely used they significantly reduce substation earth resistance values. This is particularly beneficial in reducing the rise of earth potential that can occur at primary substations. Modern cables have an insulating serving (typically PVC or XLPE) and therefore they do not contribute to substation earthing systems.

As PILC cable is replaced with new cable the earth resistance values in urban areas are likely to rise unless steps are taken to prevent this. Given this, whenever 100m or more of HV PILC cable is to be disconnected and the severed section is located wholly or partially within a 400m radius of a primary substation, then bare 70mm² copper conductor shall be laid in parallel with any newly installed HV cable and bonded to the cable screen at the end which is electrically closest to the primary substation in accordance with ST: CA2W. The bare copper conductor shall extend to the far end of the new HV cable or for 200m, whichever is the lesser. Where the bare copper conductor enters or exits a substation it shall alternatively be bonded to the substation's HV earthing system. Where the primary substation is a hot site the installer shall notify Primary System Design to give them the opportunity to re-assess the need for the bare copper conductor.

6 LV EARTHING

6.1 System Earthing

Requirements for earthing the LV side of distribution transformers are specified in sections 5.4 to 5.6 inclusive, and the statutory requirements for LV earthing are discussed in Section 3.1.

The LV system shall either comprise of a combined neutral and earth (CNE) system, where a single conductor provides both the neutral and protective (earthing) functions, as a separate neutral and earth system (SNE) where the neutral and protective functions are provided by two separate conductors or as a mixed CNE and SNE system.

The type of earthing that may be provided to customers depend on the LV system earthing arrangement, LV earth resistance and the nature of the customer's installation. The various types of customer earthing are listed below:

- Protective Multiple Earthing (PME)
- Protective Neutral Bonding (PNB)
- Separate Neutral and Earth (SNE)

- Direct Earthing.

6.1.1 General LV System Earthing Requirements

The supply neutral conductor of three phase and split phase systems shall, as a minimum, have half the current capacity of the phase conductors. The supply neutral conductor of a single phase system shall have a current carrying capacity at least as high as the phase conductor.

Fuses or switches shall not be placed within the supply neutral conductor.

CNE systems shall not be used within customer owned electrical installations, however, it is acceptable to combine neutral and protective functions within a “distribution system” (including distribution systems operated by third parties such as street lighting authorities).

The maximum resistance for LV earthing systems is specified in 4.1.2.

6.1.2 Protective Multiple Earthing (PME)

Figure 38 shows a schematic representation of a PME system (also known as a TN-C-S system). The neutral and protective (i.e. earthing) functions are combined together in the supply neutral conductor and it is therefore suitable for CNE type mains systems.

PME is Western Power Distribution’s preferred method of earthing, where the LV earth resistance is below 20 ohms and it can be applied safely.

Figure 38: PME (TN-C-S) Earthing

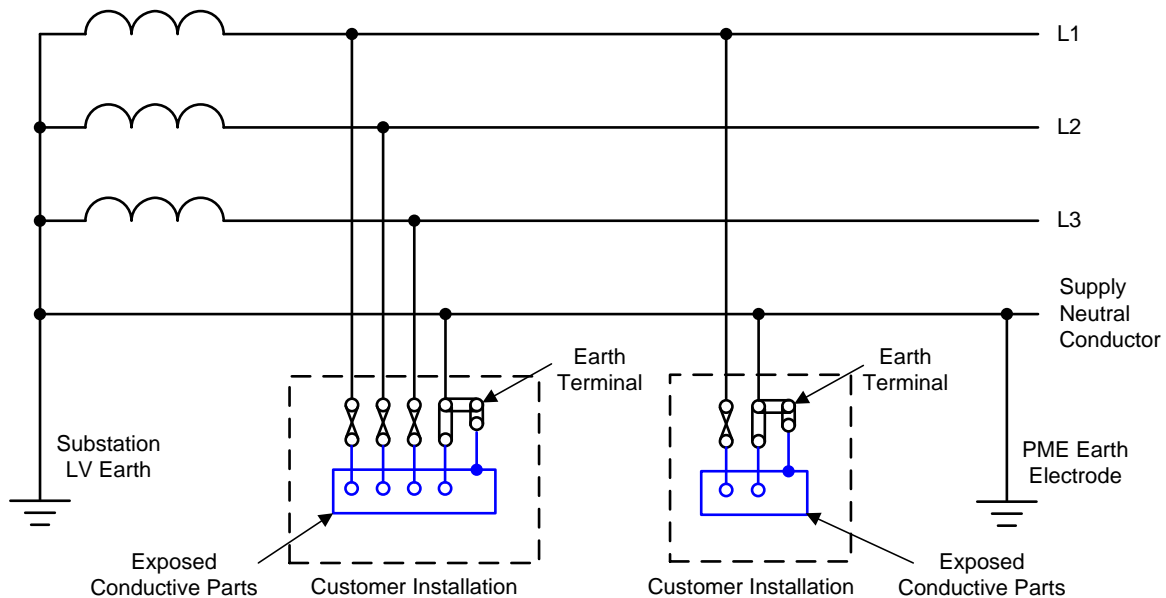

In addition to the LV earth electrode installed at the substation, extra PME earth electrodes must be installed, and connected to the supply neutral conductor to reduce the voltage rise that can occur on metalwork within customer installations if the supply neutral conductor is damaged / broken.

As a minimum, these additional PME earths shall be installed:

- at the furthest joint from the source of the cable / overhead line that connects a service to an item of street furniture (e.g. streetlight) that is provided with PME.
- at the furthest point from the source of each cable and overhead line, beyond which less than five customers are connected.
- no more than 40m from the end of each cable / overhead line spur, connected to more than one customer.

As an alternative to installing an individual PME earth electrode at the remote end of a particular line or cable, the requirements can also be satisfied by permanently connecting the supply neutral conductor to that of another LV feeder. This typically occurs where a link box or set of overhead fuse units are installed to provide back-feed facilities between two LV circuits. Figure 39 shows the practical application of these requirements.

In addition to the statutory requirements (specified above) WPD's current practice is to install additional PME earths at every 8th pole (of an overhead system) and at every underground service joint.

Figure 39: Minimum Statutory Requirement for PME Earth Electrodes

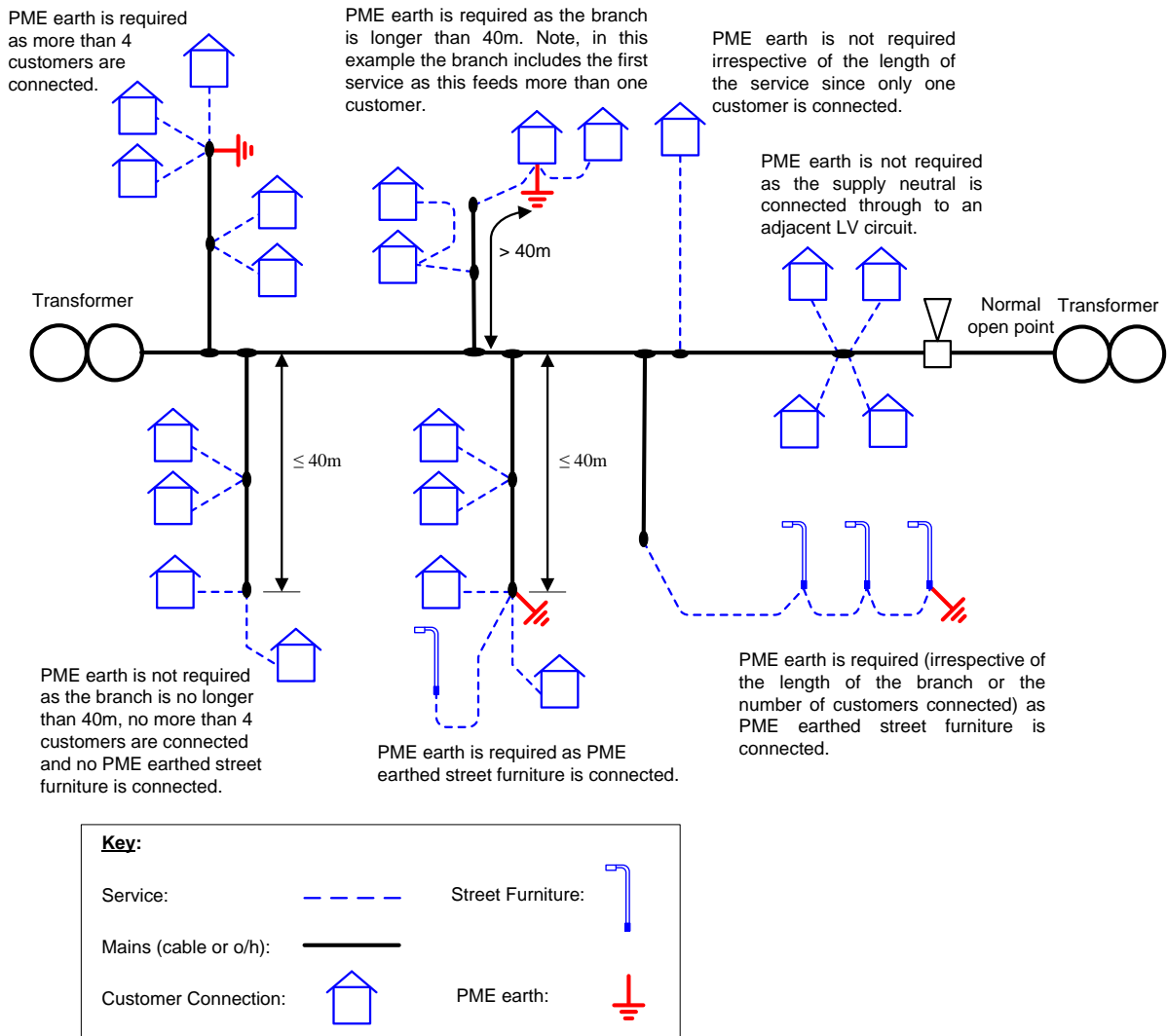

Note:

- 1) PME Earths are shown at their optimum locations (but not necessarily the most practical positions). Alternative positions may also satisfy the requirements specified in 6.1.2.
- 2) For overhead networks it is WPD practice to install a PME earth electrode at every 8th pole (as a minimum).
- 3) For underground networks it is WPD practice to install an earth at every service joint (except where this would infringe HV to LV segregation distances).
- 4) Each PME earth electrode shown above must have a resistance of 100 ohms or less.

6.1.3 Protective Neutral Bonding (PNB)

PNB earthing is a special form of PME (TN-C-S) earthing that may only be used where the substation provides one or more connections at a single position (i.e. from a single cut-out or multi-way distribution board.). See Figure 40.

Western Power Distribution's LV earth electrode is installed adjacent to the customer's building and connected to the supply neutral conductor either just outside the customer's property (e.g. using an under-eaves cable joint box) or at the incoming side of the cut-out or distribution board (also see Figure 29 and Figure 30).

Figure 40: Protective Neutral Bonding (PNB)

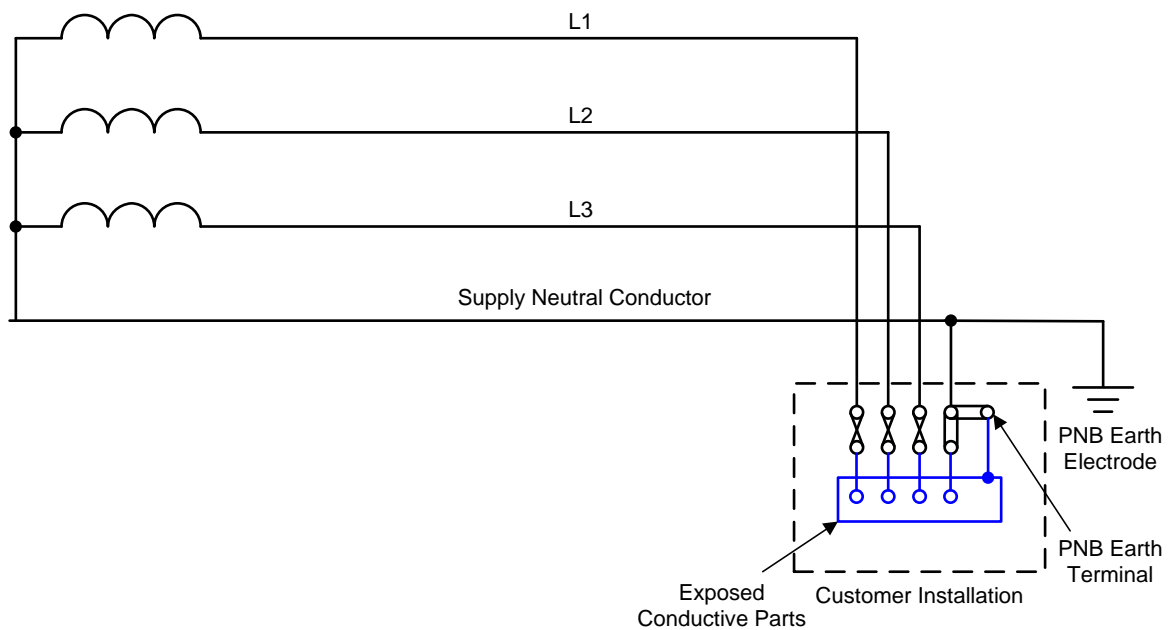

Note:

- 1) WPD's PNB earth electrode is shown connected to the supply neutral conductor outside the customer's property. It is also acceptable for this connection to be made at the incoming terminals of the cut-out.

6.1.4 Separate Neutral and Earth (SNE)

Cable Sheath Earthing and Separate Continuous Aerial Earth Wire systems are both known as SNE (or TN-S) earthing. These systems were commonly used prior to the introduction of PME. See Figure 41.

Cable sheath earthing is used where separate neutral and earth cables are installed (e.g. 3 phase 4 core cables and single phase split concentric cables).

Continuous Aerial Earth Wire systems may be applied to open wire overhead lines and to aerial bundled conductor (ABC) lines (where an additional earth wire is installed).

Although SNE is not the preferred earthing arrangement it may still be installed or retained where PME is not suitable.

Figure 41: Separate Neutral and Earth (SNE)

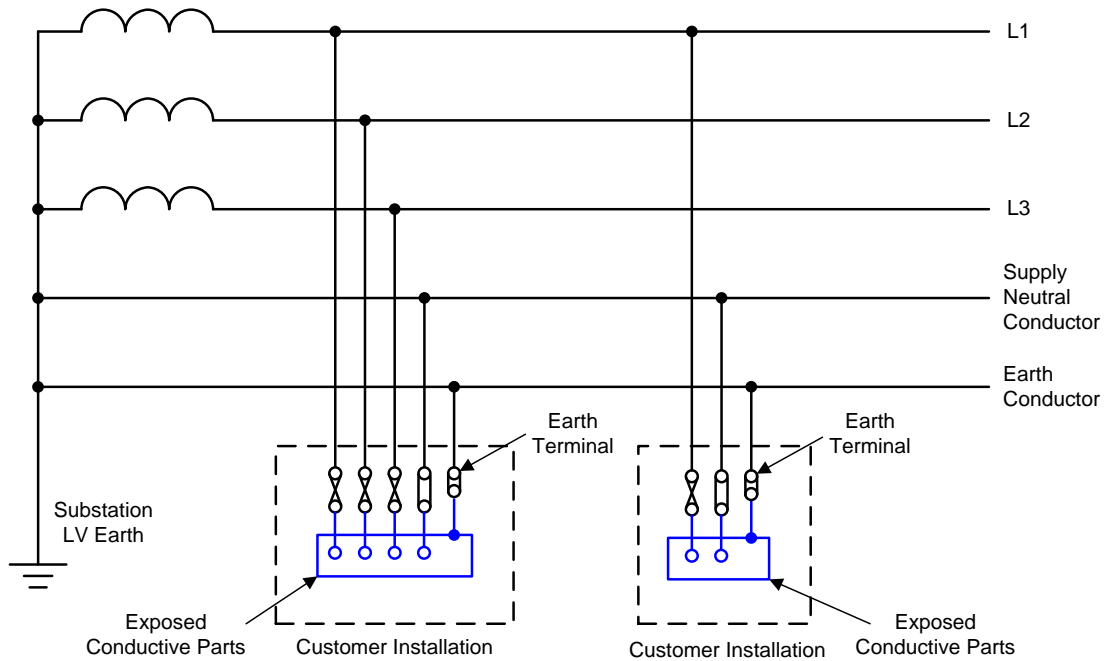

6.1.5 Direct Earthing

Direct earthing (also known as TT) may be provided from either CNE or SNE mains systems. In this case Western Power Distribution does not provide the customer with an earth terminal at all and the customer must install and maintain their own earth electrode system. See Figure 42. Of all the possible earthing options this is the least favourable.

In the past, customers often used the installation’s incoming metal water pipe as their earth electrode. This practice is no longer acceptable since Water Distribution Companies now install plastic pipes (e.g. polyethylene) therefore the electrical integrity of existing pipe-work can no longer be relied upon.

Where a customer uses direct earthing they invariably have to install a residual current device (RCD) in order to satisfy requirements specified within BS 7671 (Requirements for Electrical Installations, IET Wiring Regulations).

Figure 42: Direct Earthing

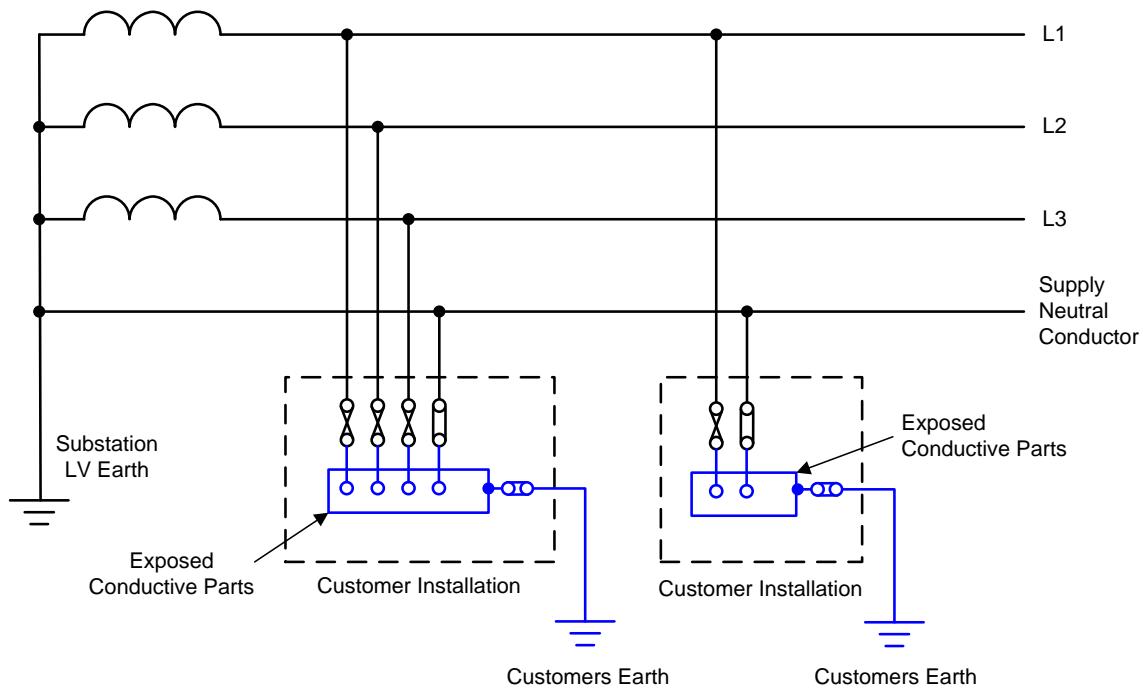

6.2 Provision of SNE and PME Earthing Terminals

Western Power Distribution have a legal obligation under the Electricity Safety, Quality and Continuity Regulations 2004 to offer an earthing terminal when providing a new connection at low voltage, unless it is unsafe to do so. In such cases it is acceptable to provide customers with PME, SNE or PNB type earthing terminals, although PME is the preferred option where it can be provided safely. If the cost of providing a PME, SNE or PNB earth terminal is prohibitive the customer should be given the option to choose direct earthing, if they wish.

There is no legal obligation on Distribution Companies to provide an earth terminal at existing installations (e.g. when renewing or moving a service) but earth terminals should be provided, on request, where it is technically and economically acceptable to WPD. Further details are provided in ST: TP21E.

The nature of the mains system, e.g. whether it is combined neutral and earth (CNE) or a separate neutral and earth (SNE), has a significant bearing on the provision of PME and SNE earth terminals. The following types of system are considered:

- CNE mains system designed for PME connections.
- SNE mains system that has not been converted for PME connections.
- SNE mains system that has been converted for PME connections.
- Mixed CNE / SNE mains system that has been converted for PME connections.

6.2.1 CNE Mains System designed for PME Connections

New systems installed by WPD are normally constructed using cables and overhead lines with combined neutral and earth conductors (e.g. 3 core wavecon cable and aerial bundled conductor (ABC) overhead lines).

Customers shall be offered a PME earth terminal by default, as long as:

- the LV resistance is 20 ohms or below
- it is safe and economic to do so

SNE earth terminals may be provided where there is an earth electrode beyond the connection (i.e. further from the source substation than the position of the connection) has a resistance of 10 ohms or less.

If the above requirements are not met and it is unsafe to provide PME (due to the type of installation, its electrical design or due to inadequate bonding) direct earthing shall be provided instead (see Figure 43). Further guidance on customer earthing is provided in ST: TP21E.

6.2.2 SNE Systems that HAVE NOT been designed or modified for PME earthing

Historically LV systems were constructed using SNE cables and/or overhead lines. Many of these have since been modified to allow PME earthing to be provided (e.g. PME earth electrodes installed). Where these modifications have not been carried out, and it is not practical or economic to do so, new customers shall be offered SNE earthing as standard. PME earthing is not available. (See Figure 44).

6.2.3 SNE Systems that HAVE been modified for PME earthing

Many SNE system have been converted to allow PME earth terminals to be provided to customers. The type of customer earthing that may be offered (or retained) in such circumstances is specified in Figure 45.

6.2.4 Mixed SNE and CNE systems

As existing SNE LV systems are extended, augmented and replaced this is usually carried out using CNE type cable or overhead line. The type of customer earthing that can be offered or retained in these circumstances is shown in Figure 46 and Figure 47.

6.2.5 Service Cables / Overhead Lines

The type of service that is installed (CNE or SNE) is determined by the earthing facilities at the connection. Whenever a length of service cable is laid into an existing service (e.g. to repair a fault) the same type of cable shall be used. Table 8 summarises these requirements.

Where services are looped the requirements listed in Table 8 apply to the entire route of the service (i.e. from the associated customer cut-out to the mains joint / termination).

Table 8: Service Cable Requirements

Customer Earthing Facility	Service Type
PME	<ul style="list-style-type: none">• CNE service is preferred• Existing SNE service cable / line may be retained
SNE	<ul style="list-style-type: none">• SNE service cable / line (from the associated cut-out back to the mains joint / termination) is required.• CNE service is not acceptable.
Direct Earthing (customer installs own earth terminal)	<ul style="list-style-type: none">• CNE service is preferred• Existing SNE service cable / line may be retained

6.2.6 Charging Arrangements for Providing or Modifying Earth Terminals

As a general principle, the person or organisation who requests an earth terminal or who initiates work that causes modifications to be made to the earthing system, shall pay all the associated earthing costs. For example, where a new connection is requested the earthing costs shall be included within the connection charge.

If changes are proposed that require existing SNE customers to convert to PME or Direct Earthing, Western Power Distribution shall inform these customers and make arrangements for a suitably qualified electrical installer to check the installations and to carry out any required modifications. The costs associated with this work shall be paid for by Western Power Distribution and not by the affected customers. Where these earthing changes are due to a new business scheme, augmentation or a diversion the costs should be passed on to person / organisation that initiated the work.

Figure 43: Provision of Earth Terminals - CNE system

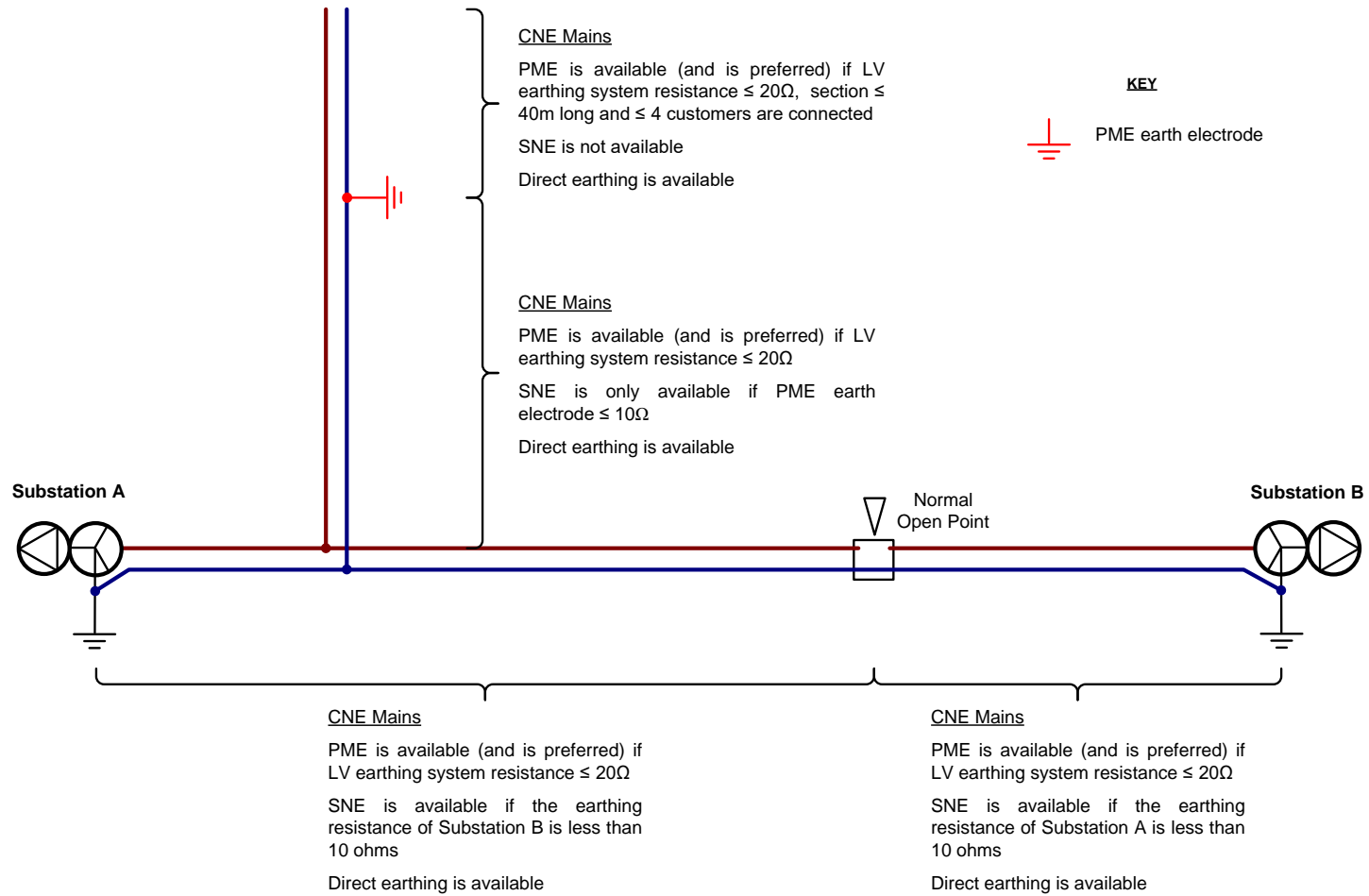

Figure 44: Provision of Earth Terminals - SNE system that HAS NOT been modified for PME earthing

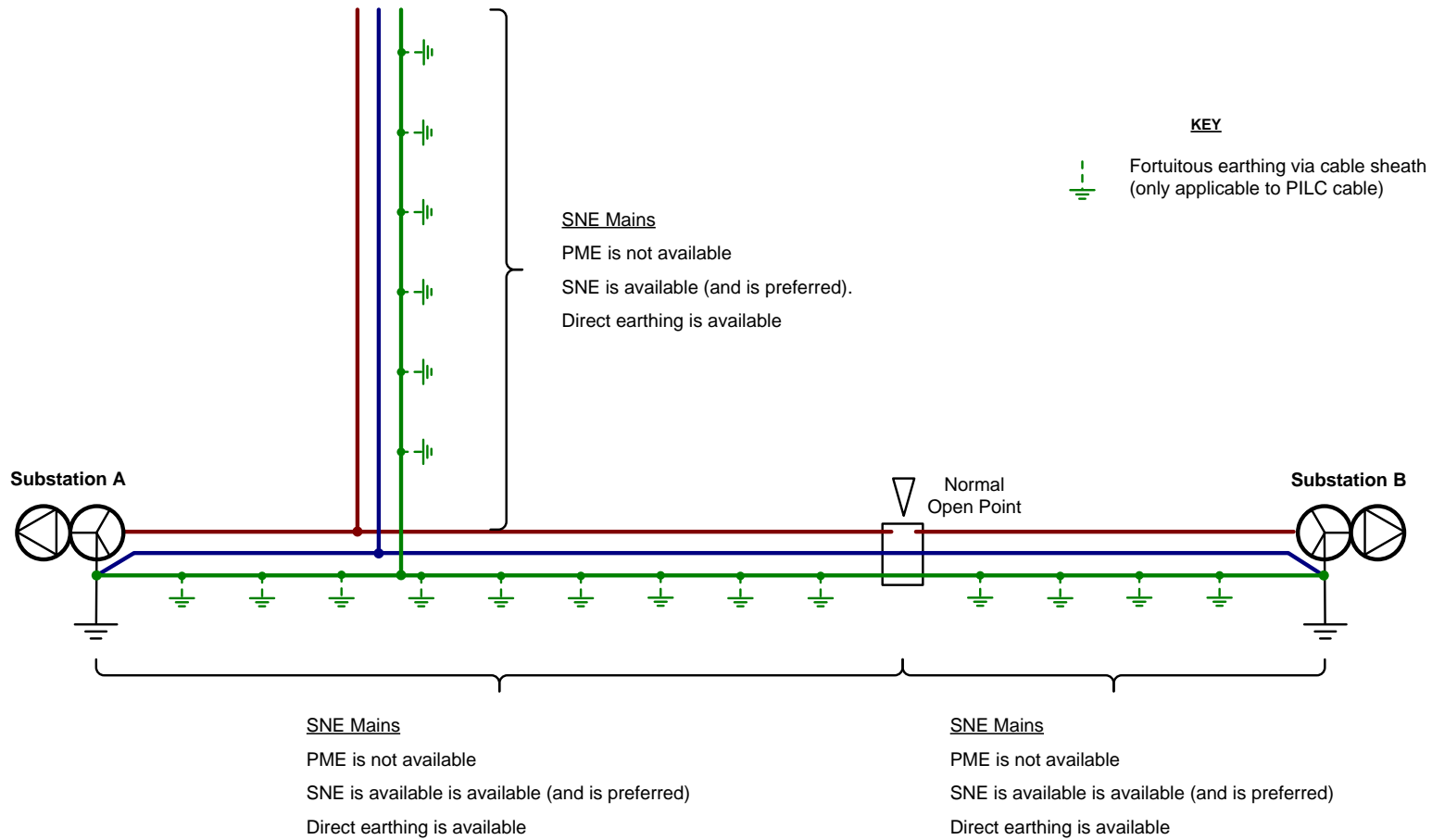

Figure 45: Provision of Earth Terminals - SNE system that HAS been modified for PME earthing

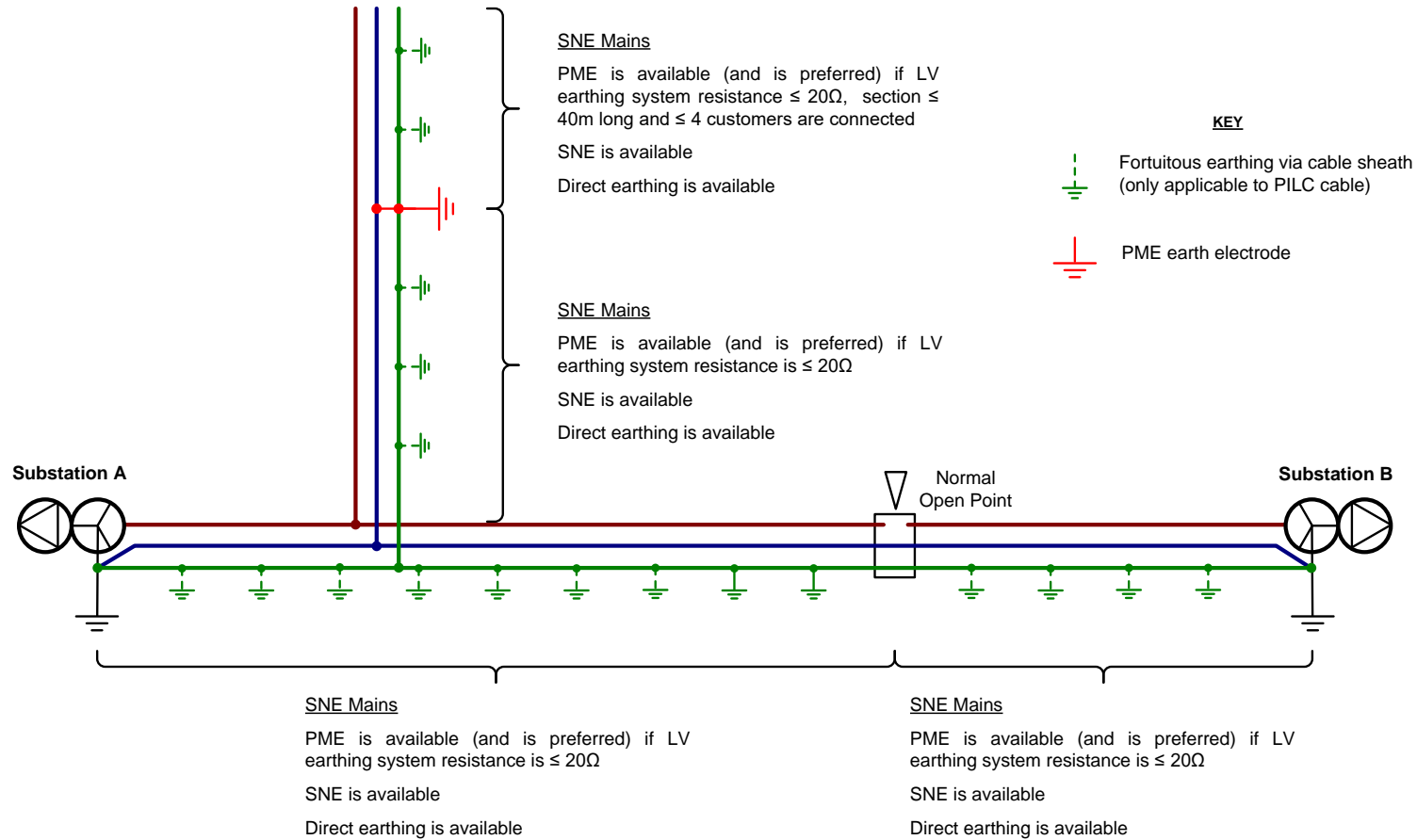

Figure 46: Provision of Earth Terminals – Mixed SNE / CNE system (Part 1)

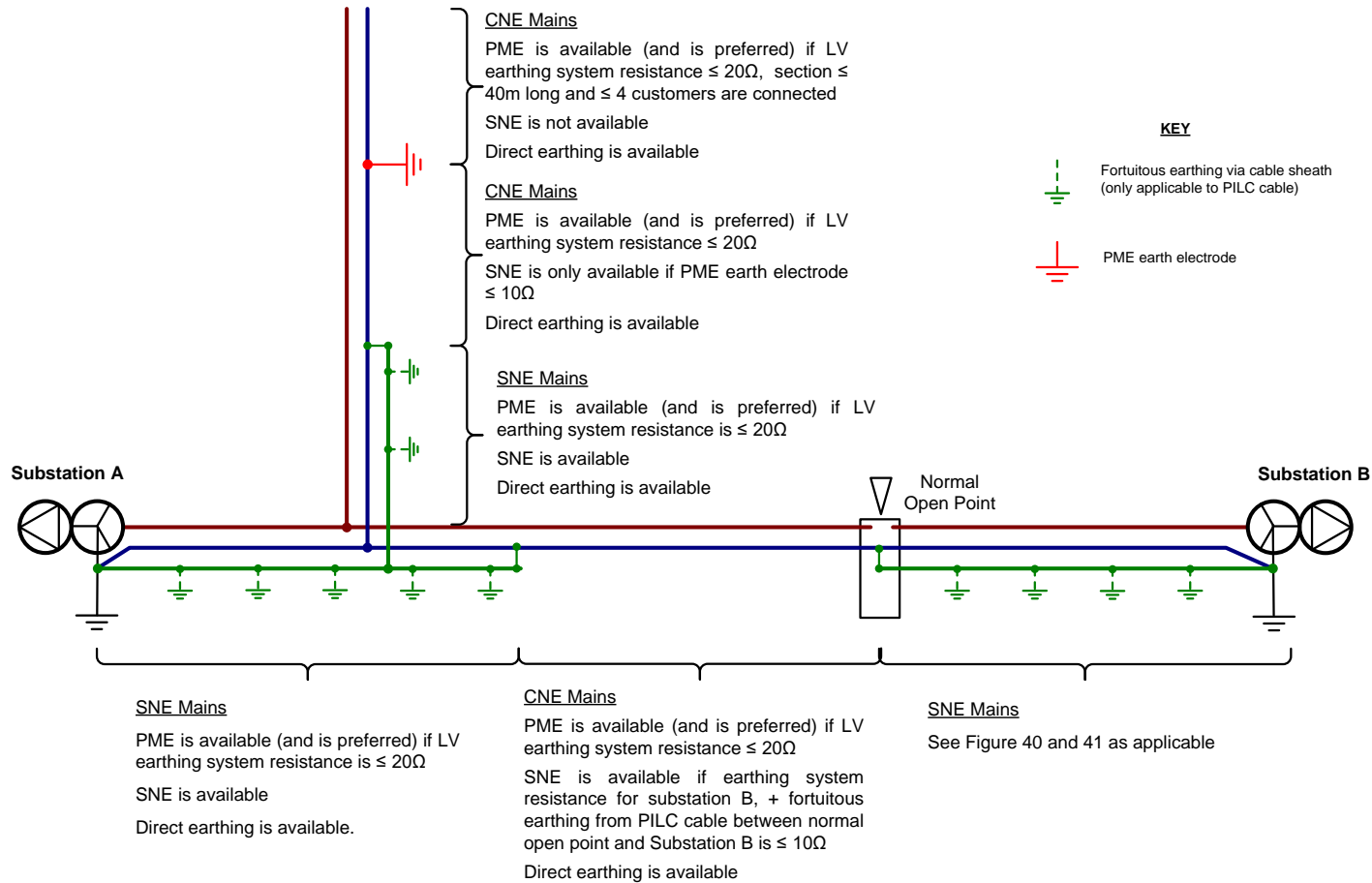
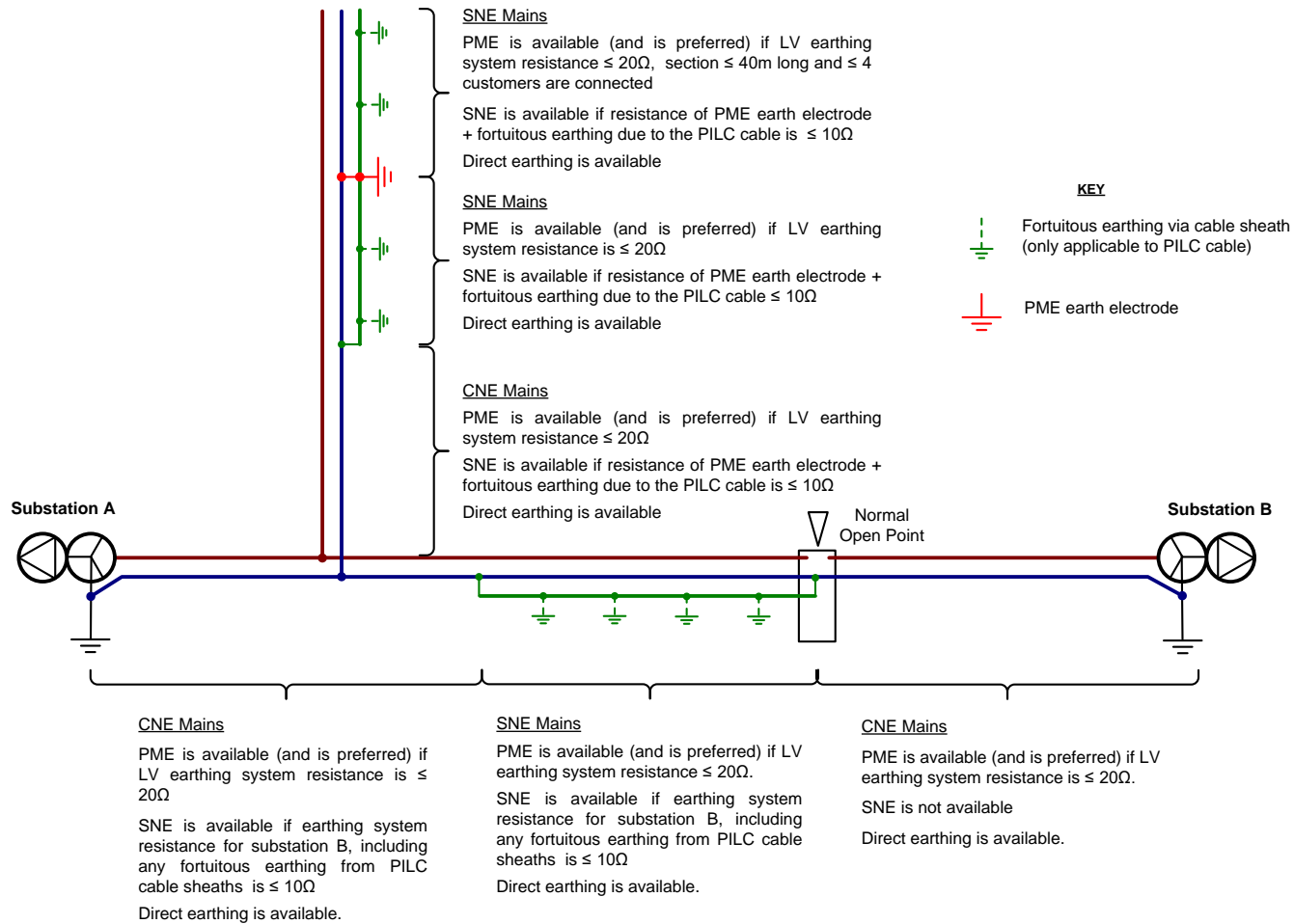

Figure 47: Provision of Earth Terminals – Mixed SNE / CNE system (Part 2)



7 BACKGROUND INFORMATION

7.1 Earth Electrode Thermal Calculations

Thermal requirements for earth electrode designs are specified in section 4.2 and are based upon detailed fault rating and surface area calculations described below.

7.1.1 Fault Ratings

The following equation is used to determine the conductor rating:

$$i_c = Ak \left(\frac{1}{t} \log_e \left(\frac{\theta_f + \beta}{\theta_i + \beta} \right) \right)^{1/2}$$

- i_c rated current (A)
- A cross-sectional area of conductor (mm²)
- θ_i initial temperature of conductor (°C) (30°C for earthing conductor and electrode)
- θ_f final temperature of conductor (°C) (405°C for bare copper with brazed or welded connections, 250°C for bare copper with crimped or bolted connections and 160°C for PVC insulated copper)
- β reciprocal of temp. coef. of resistance for conductor (234.5 for copper).
- k constant depending on conductor material (226 for copper)

Fault ratings for a number of commonly used earth conductors are given below:

Conductor	1s Rating	3s Rating
35mm ² un-insulated copper	7.43kA (brazed / welded) 6.15kA (crimped / bolted)	4.29kA (brazed / welded) 3.55kA (crimped / bolted)
70mm ² un-insulated copper	14.86kA (brazed / welded) 12.31kA (crimped / bolted)	8.58kA (brazed / welded) 7.10kA (crimped / bolted)
35mm ² PVC insulated copper	5.00kA	2.89kA
70mm ² PVC insulated copper	10.00kA	5.58kA

7.1.2 Surface Area of Electrode

The required surface area of earth electrode is calculated using the following equation:

$$A = \frac{1000 \times I_f}{\left(\frac{57.7}{\rho \cdot t}\right)^{1/2}}$$

- A Required surface area of buried electrode (mm²)
 ρ Soil resistivity (ohm.m)
 t Duration of fault (s)
 I_f Fault current flowing through electrode (A)

The fault duration is dependent on the maximum protection clearance time, which is, in turn, dependent on the fault current. For substations without a continuous cable path back to the primary substation the fault current is dictated by the source impedance, primary substation electrode resistance and distribution substation earth resistance.

For the purposes of the standard electrode designs listed in Table 4 the following assumptions were made:

- Positive and Zero Sequence Source Impedance = $j2.12\Omega$ (corresponding to an 11kV earth fault level of 3000A).
- Resistance of Primary Substation Earth Grid = 0.5Ω
- IDMT earth fault protection setting = 240A with a 0.4 TM (standard inverse curve)
- SEF protection setting = 12A with a 12s definite time delay.

7.1.3 Worked Example 3

If 75m length of horizontal 70mm² conductor (Arrangement C) is installed in 100 ohm.m soil an electrode resistance of 2.7 ohms would be expected (from Table 4). Using the above assumptions the fault current would be:

$$\begin{aligned} I_f &= (11000/\sqrt{3})/(2.7+0.5+j2.12) \\ &= 6350/(3.2^2 + 2.12^2)^{0.5} \\ &= 1654A \end{aligned}$$

The operating time of the protection (with a 240A 0.4tm Standard Inverse setting) is given by the following formula:

$$t = 0.14.T/[(I_f / I_s)^{0.02}-1]$$

Where:

$$\begin{aligned} T &= \text{Relay Time multiplier} \\ I_s &= \text{Relay Current Setting} \end{aligned}$$

From which:

$$\begin{aligned} t &= 0.14 \times 0.4 / [(1654/240)^{0.02}-1] \\ &= 1.423s \end{aligned}$$

With a soil resistivity of 100 ohm.m then the minimum surface area of the electrode (A) is given by the following equation:

$$\begin{aligned} A &= 1000 \times 1654 / (57.7/(100 \times 1.43))^{0.5} \\ &= 2,603,848 \text{ mm}^2 \end{aligned}$$

A 1000mm length of 70mm² copper earth electrode has an area of approximately 29700 mm² and a standard 1.5m long, 12.5mm diameter earth rod has a surface area of 19634 mm². For Arrangement C the surface area of 75m of electrode and one earth rod would be:

$$19634 + 75 \times 29700 = 2,247,134 \text{ mm}^2$$

The 75m electrode does not satisfy the required surface area requirement.

7.1.4 Worked Example 4

If the electrode in Worked Example 3 is extended to 100m:

- electrode resistance would be 2.1 ohms (from Table 4)
- fault current increases to 1893A *
- protection clearance reduces to 1.32s *
- required surface area of the electrode increases to 2,863,187 mm² *

The actual surface area of the 100m electrode is 2,989,634 mm² and is sufficient for this application. * See Worked Example 3 for calculation method

7.2 HV And LV Earth Segregation

Regulation 8. – (2) (b) of The Electricity Safety, Quality and Continuity Regulations 2002 imposes a duty on Distributors and Generators to ensure that “earth electrodes are designed, installed and used in such a manner so as to prevent danger occurring in any low voltage network as a result of any fault in the high voltage network”.

Danger is defined as “danger to health or danger to life or limb from electric shock, burn, injury or mechanical movement to persons, livestock or domestic animals, or from fire, or explosion attendant upon the generation, transmission, distribution or use of energy.

Section 3.2 demonstrates how rise of potential in earth electrode systems can give rise to hazardous step, touch and transfer potentials if not adequately controlled. The following diagrams show how faults in the HV system cause earth potential rise at a distribution substation.

Figure 48 shows a fault on the HV side of a distribution transformer connected via overhead line. All the earth fault current flows through the distribution transformer’s earth electrode to return to the primary substation. This causes a high rise of potential (i.e. above 430V).

Figure 48: Rise of Potential (Overhead Line Fed Substation)

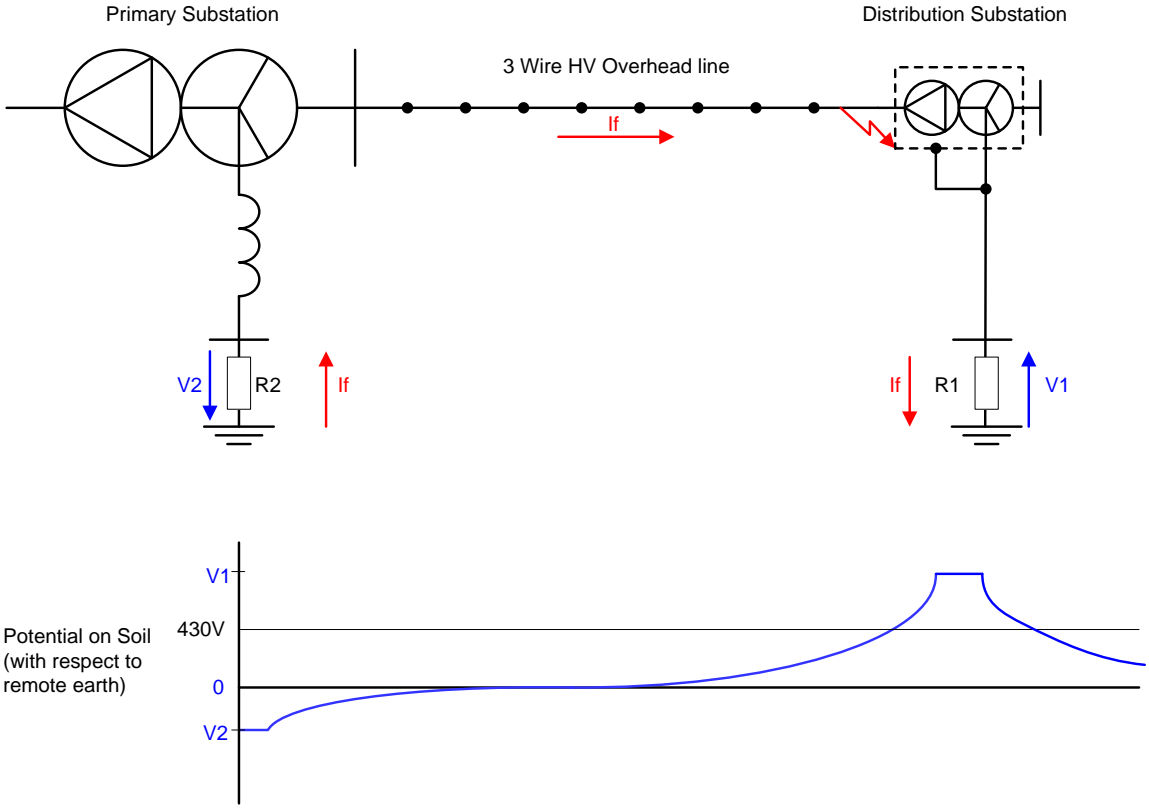

Figure 49 shows a similar fault, but this time the distribution transformer is connected by underground cable. Most of the earth fault current returns via the cable sheath (which has a low impedance compared to the earth electrode). This low impedance path ensures the rise of earth potential is relatively low (i.e. less than 430V).

Figure 49: Rise of Potential (Cable Fed Substation)

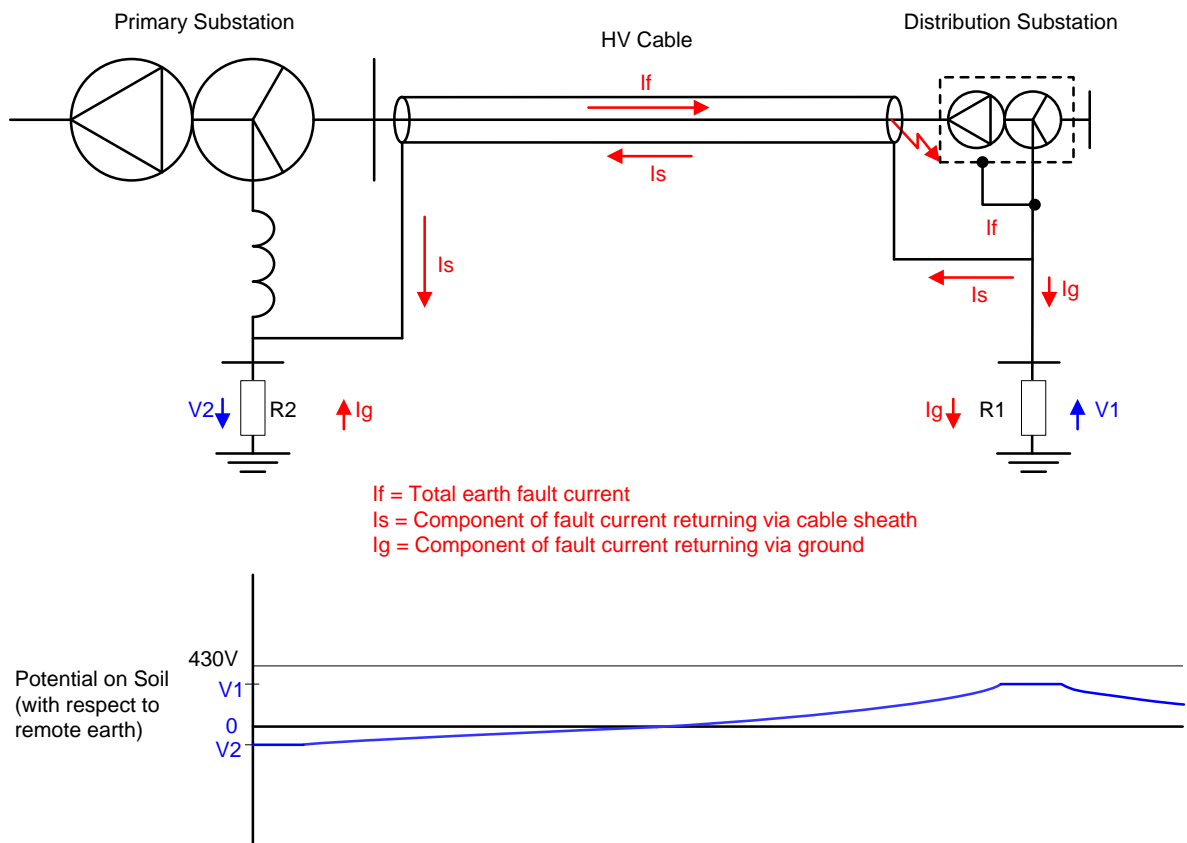

Figure 50 shows a fault at a primary substation. In this case some of the fault current flows down the cable sheath and enters the ground through the distribution substation earthing system, raising its earth potential. If the primary substation is a “hot site” it is possible that the distribution substation is hot as well.

Figure 50: Rise of Potential Transferred from Primary Substation

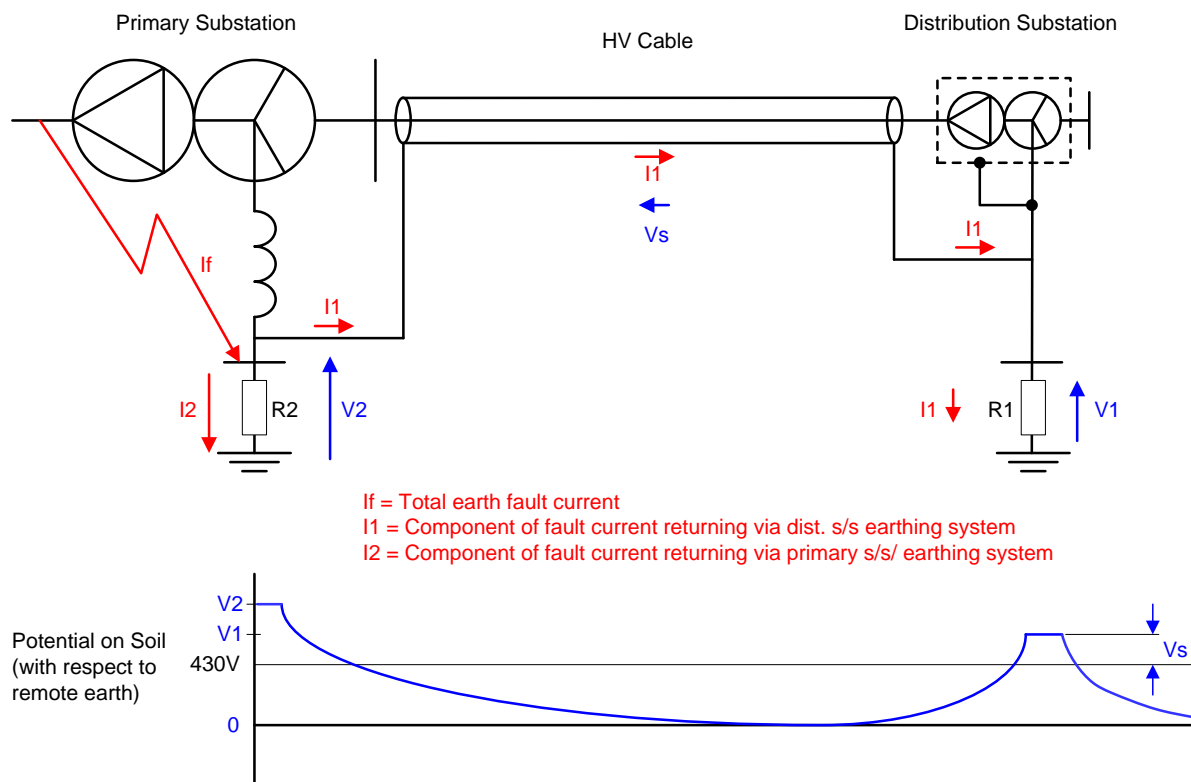

Figure 51 and Figure 52 shows how potential rise in an HV earthing system is transferred into the LV network. Figure 51 shows a distribution substation with combined HV and LV earthing whilst Figure 52 shows a substation with segregated HV and LV earthing.

In both cases a potential (V_1) between the neutral/earth of the installation and the surrounding soil and a potential (V_2) between neutral / earth and remote earth occurs. Both of these potentials are significantly reduced by segregating the HV and LV earthing systems.

Figure 51: Transfer Potentials - Combined HV and LV Earthing

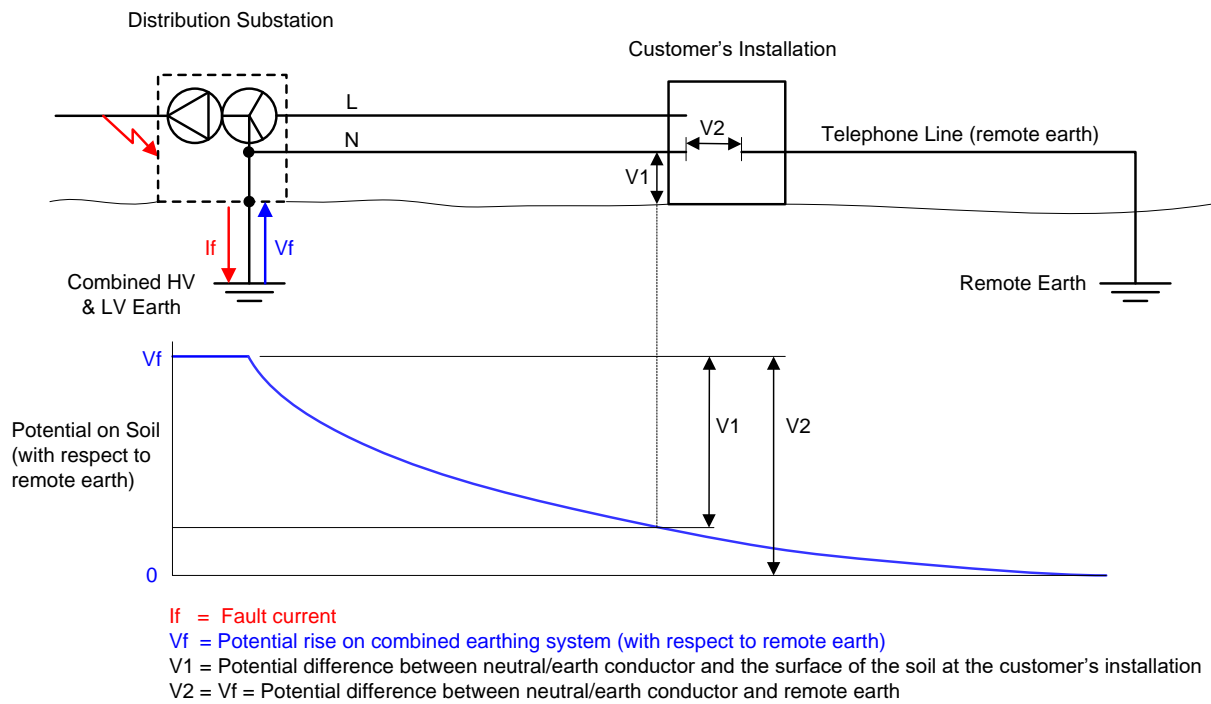
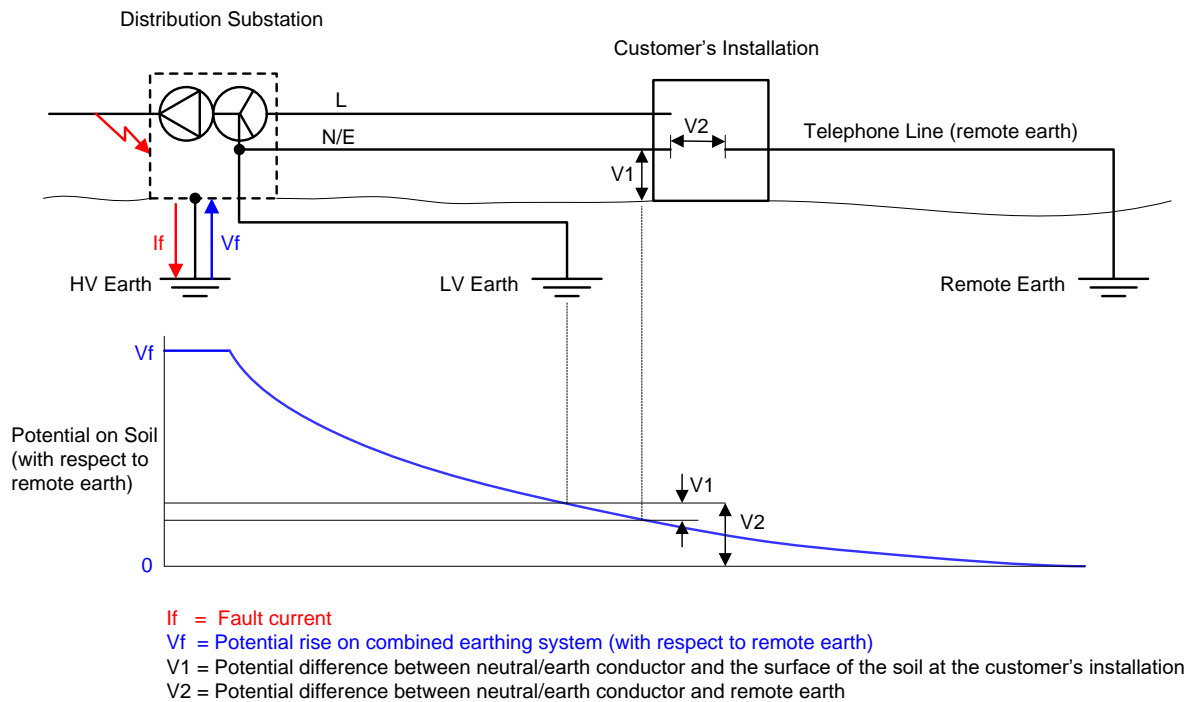

Figure 52: Transfer Potentials - Segregated HV and LV Earthing



7.3 Resistivity Of Different Soil / Rock Types

Description of Rock / Soil	Resistivity (Ωm)	
	Range	Typical Value
Alluvial & Lighter Clays	1 to 5	5
Other Clays	5 to 100	10
Marls (e.g. Kreuper Marl)	10 - 300	50
Sand / Sandy Gravel	50 to 3000	200
Porous Limestone (e.g. Chalk)	30 to 100	50
Porous Sandstone (e.g. Kreuper Sandstone & Clay Shales)	30 to 300	100
Quartzite & Crystalline Limestone	100 to 1000	300
Clay Slates & Slatey Shales	300 to 3000	1000
Gneiss / Igneous Rock	2000+	

APPENDIX A

SUPERSEDED DOCUMENTATION

This document supersedes ST: TP21D/3 dated March 2018 which has now been withdrawn.

APPENDIX B

RECORD OF COMMENT DURING CONSULTATION

No consultation as there were no changes.

APPENDIX C

ANCILLARY DOCUMENTATION

POL: TP12 Fixed Earthing Systems

ST: TP21A Safety Limits for Touch and Step Voltages – Earthing System Design/Assessment

ST: TP21B Design and Installation of Fixed Earthing Systems - Major Substations

ST: TP21E Provision of WPD Earth Terminals To Customer LV Installations

ST: TP21L Fixed Earthing Systems - Construction Techniques - Jointing

ST: TP21O Measurements Associated with Earthing Systems

ENA Technical Specification 41-24; Guidelines for the Design, Installation, Testing and Maintenance of Main Earthing Systems in Substations.

ENA Engineering Recommendation G12; Requirements for the Application of Protective Multiple earthing to Low Voltage networks.

ENA Engineering Recommendation S34; A Guide for Assessing the Rise of Earth Potential at Substation Sites.

APPENDIX D

KEYWORDS

Earthing, Grounding, PME, SNE, PNB, Direct Earthing.